

Display Elektronik GmbH

DATA SHEET

TFT MODULE

**DEM 1024600A
TMH-PW-N (A-TOUCH)**

7,0" TFT + Touch

Product Specification

Ver.: 1

19.12.2014

Revision History

Revision	Date	Detail
0	17.12.2014	Initial Release
1	19.12.2014	Add LED Lifetime

Table of Contents

No.	Item	Page
1.	General Description	4
2.	Module Parameter	4
3.	Absolute Maximum Ratings	4
4.	DC Characteristics	5
5.	Backlight Characteristic	6
5.1.	Backlight Characteristic	6
5.2.	Backlighting circuit	6
6.	Optical Characteristics	7
6.1.	Optical Characteristics	7
6.2.	Definition of Response Time	7
6.3.	Definition of Contrast Ratio	8
6.4.	Definition of Viewing Angles	8
6.5.	Definition of Color Appearance	9
6.6.	Definition of Surface Luminance, Uniformity and Transmittance	9
7.	Block Diagram and Power Supply	10
8.	Interface Pins Definition	11
9.	Timing Characteristics	13
10.	Power Sequence	16
11.	Quality Assurance	17
11.1	Purpose	17
11.2	Standard for Quality Test	17
11.3	Nonconforming Analysis & Disposition	17
11.4	Agreement Items	17
11.5	Standard of the Product Visual Inspection	18
11.6	Inspection Specification for the TFT module	18
11.8	Classification of Defects	22
11.9	Identification/marketing criteria	22
11.10	Packaging	22
12.	Reliability Specification	23
13.	Precautions and Warranty	24
13.1	Safety	24
13.2	Handling	24
13.3	Storage	24
13.4	Metal Pin (Apply to Products with Metal Pins)	24
13.5	Operation	25
13.6	Static Electricity	25
13.7	Limited Warranty	25
14.	Outline Drawing	26

1. General Description

The specification is a transmissive type color active matrix liquid crystal display (LCD) which uses amorphous thin film transistor (TFT) as switching devices. This product is composed of a TFT-LCD panel, driver ICs, a touch panel and a backlight unit.

2. Module Parameter

Features	Details	Unit
Display Size (Diagonal)	7.0"	-
LCD type	TN TFT	-
Display Mode	Transmissive / Normally White	-
Resolution	1024 x RGB x 600	Pixels
View Direction	12 O'clock	Best Image
Gray Scale Inversion Direction	6 O'clock	-
Module Outline	165.75 x 105.39 x 4.75 (Note1)	mm
Active Area	153.60 x 90.00	mm
Pixel Pitch	0.150 x 0.150	mm
Pixel Arrangement	RGB Vertical Stripe	-
Display Colors	16.7 Million	-
Interface	6-Bits/8-Bits LVDS Interface	-
With or Without Touch Panel	With 4-Resistive-Touch-Panel integrated	-
Operating Temperature	-20 to +70	°C
Storage Temperature	-30 to +80	°C
Weight	t.b.d.	g

Note 1: Exclusive hooks, posts, FFC/FPC tail etc.

3. Absolute Maximum Ratings

$V_{SS}=0V$, $T_a=25^{\circ}C$

Item	Symbol	Min.	Max.	Unit
Supply Voltage	VDD	-0.3	5.0	V
	AVDD	6.5	13.5	V
Gate On Voltage	VGH	-0.3	42.0	V
Gate Off Voltage	VGL	-20.0	0.3	V
Gate On-Gate off Voltage	VGH-VGL	-	40	V
Storage temperature	T _{STG}	-30	+80	°C
Operating temperature	T _{OP}	-20	+70	°C

Note 1: If T_a below $50^{\circ}C$, the maximal humidity is 90%RH, if T_a over $50^{\circ}C$, absolute humidity should be less than 60%RH.

Note 2: The response time will be extremely slow when the operating temperature is around $-10^{\circ}C$, and the back ground will become darker at high temperature operating.

4. DC Characteristics

Item		Symbol	Min.	Typ.	Max.	Unit
Supply Voltage	Logic	VDD	3.0	3.3	3.6	V
	Analog	AVDD	10.8	11	11.2	V
Gate On Voltage		VGH	19.7	20	20.3	V
Gate Off Voltage		VGL	-6.5	-6.8	-7.1	V
Common Voltage		VCOM	2.7	(3.7)	4.7	V
Input Logic High Voltage		VIH	0.7*DVDD	-	DVDD	V
Input Logic Low Voltage		VIL	0	-	0.3*DVDD	V

Note 1: Be sure to apply DVDD and VGL to the LCD first, and then apply VGH.

Note 2: DVDD setting should match the signals output voltage (refer to Note 3) of customer's system board.

Note 3: LVDS, Reset.

Note 4: Typ. VCOM is only a reference value, it must be optimized according to each LCM. Be sure to use VR

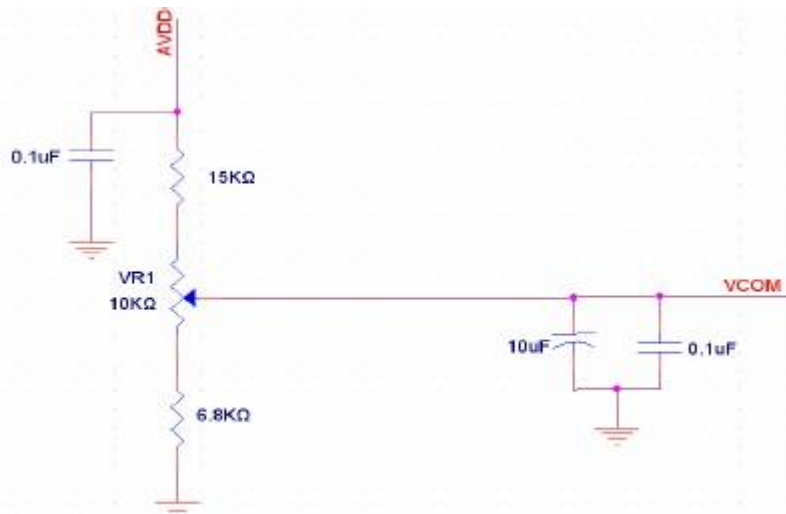

Item	Symbol	Min.	Typ.	Max.	Unit	Remark
Current for Driver	IGH	-	0.25	1.0	mA	VGH=20V
	IGL	-	0.25	1.0	mA	VGL=-6.8V
	IVDD	-	38	60	mA	DVDD=3.3V
	IAVDD	-	20	30	mA	AVDD=11V

5. Backlight Characteristic

5.1. Backlight Characteristic

Item	Symbol	Condition	Min.	Typ.	Max.	Unit
Forward Voltage	V _F	Ta=25 °C, I _F =20mA/LED	8.7	9.3	10.2	V
Forward Current	I _F	Ta=25 °C, V _F =3.1/LED	-	180	-	mA
Power Dissipation	P _D		-	1674	-	mW
LED Lifetime (25°C)	-	-	-	(30.000)	-	Hrs
Uniformity	Avg		75	-	-	%
Drive Method	Constant current					
LED Configuration	27 White LEDs (3 LEDs in string and 9 groups in parallel)					

Note: LED lifetime defined as follows: The final brightness is at 50% of original brightness.

The environmental conducted under ambient air flow, at Ta=25°C±2°C, 60% RH±5%, I_F= 20mA.

5.2. Backlighting Circuit

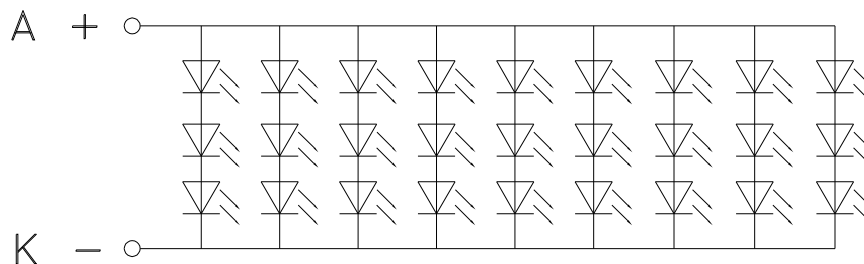

Ta=25°C, VDD=3.3V, TN LC+ Polarizer

	Item	Symbol	Condition	Specification			Unit	
				Min.	Typ.	Max.		
Backlight On (Transmissive Mode)	Luminance on TFT ($I_f=20\text{mA/LED}$)	Lv	Normally viewing angle $\theta_x = \phi_y = 0^\circ$	280	360	-	cd/m ²	
	Contrast Ratio (See 6.3)	CR		500	700	-		
	Response Time (See 6.2)	TR		-	10	20	ms	
		TF	-	15	30			
	Chromaticity Transmissive (See 6.5)	Red	XR	Backlight is on	-	TBD	-	
			YR		-	TBD	-	
		Green	XG		-	TBD	-	
			YG		-	TBD	-	
		Blue	XB		-	TBD	-	
			YB		-	TBD	-	
	White	XW	(0.233)	(0.283)	(0.333)			
		YW	(0.269)	(0.319)	(0.369)			
	Viewing Angle (See 6.4)	Horizontal	θ_{x+}	Center CR \geq 10	65	75	-	Deg.
			θ_{x-}		65	75	-	
Vertical		ϕ_{y+}	60		70	-		
		ϕ_{y-}	65		75	-		

6.2. Definition of Response Time

6.2.1. Normally Black Type (Negative)

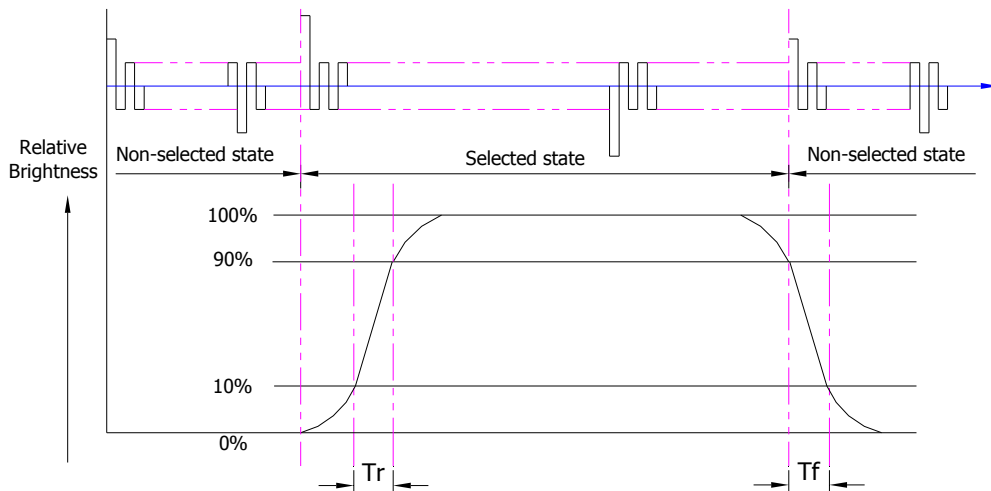

Tr is the time it takes to change from non-selected stage with relative luminance 10% to selected state with relative luminance 90%;

Tf is the time it takes to change from selected state with relative luminance 90% to non-selected state with relative luminance 10%.

Note: Measuring machine: LCD-5100

6.2.2. Normally White Type (Positive)

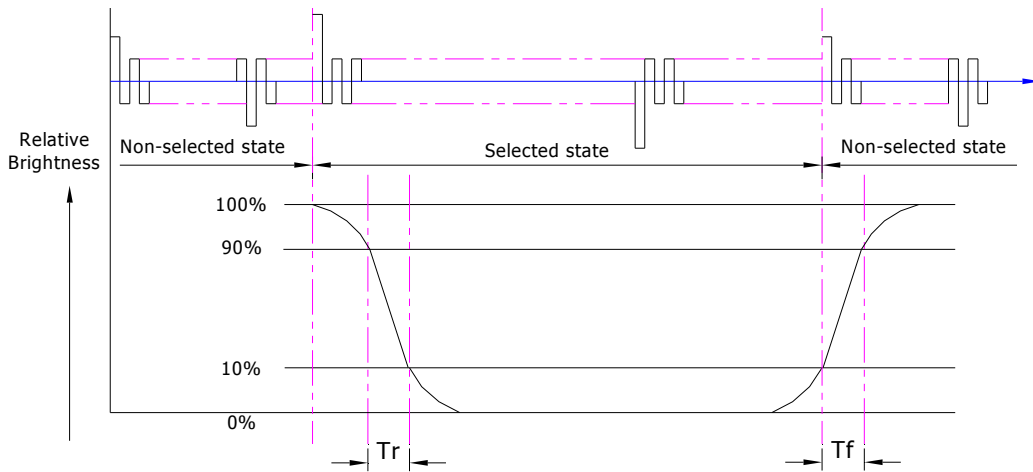

T_r is the time it takes to change from non-selected stage with relative luminance 90% to selected state with relative luminance 10%;

T_f is the time it takes to change from selected state with relative luminance 10% to non-selected state with relative luminance 90%;

Note: Measuring machine: LCD-5100 or EQUI

6.3. Definition of Contrast Ratio

Contrast is measured perpendicular to display surface in reflective and transmissive mode.

The measurement condition is:

Measuring Equipment	Eldim or Equivalent
Measuring Point Diameter	3mm//1mm
Measuring Point Location	Active Area centre point
Test pattern	A: All Pixels white
	B: All Pixel black
Contrast setting	Maximum

Definitions: CR (Contrast) = Luminance of White Pixel / Luminance of Black Pixel

6.4. Definition of Viewing Angles

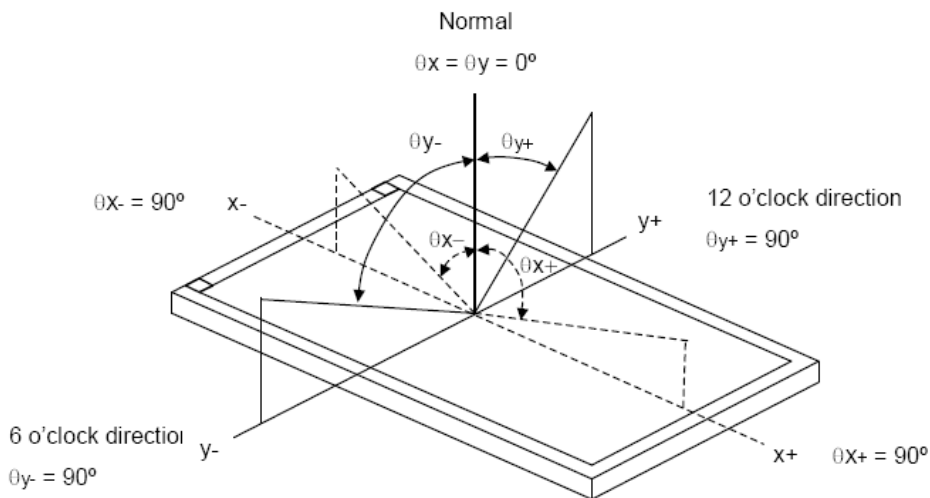

Measuring machine: LCD-5100 or EQUI

6.5. Definition of Color Appearance

R,G,B and W are defined by (x, y) on the IE chromaticity diagram

NTSC=area of RGB triangle/area of NTSC triangleX100%

Measuring picture: Red, Green, Blue and White (Measuring machine: BM-7)

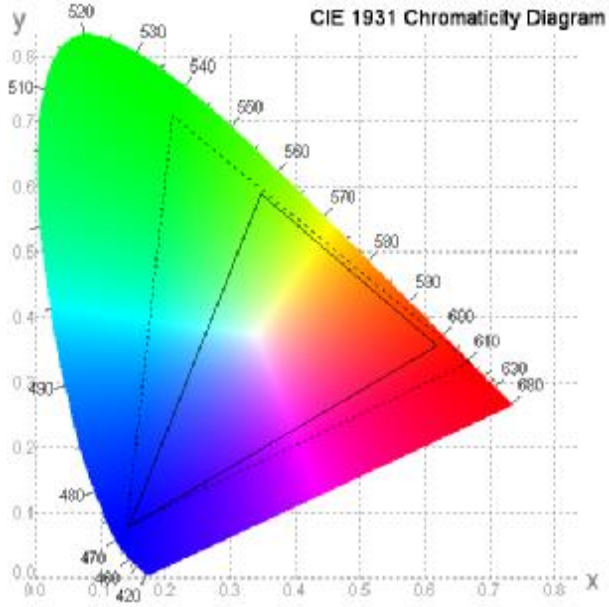

6.6. Definition of Surface Luminance, Uniformity and Transmittance

Using the transmissive mode measurement approach, measure the white screen luminance of the display panel and backlight.

6.6.1. Surface Luminance: $L_v = \text{average}(L_{P1}:L_{P9})$

6.6.2. Uniformity = $\text{Minimal}(L_{P1}:L_{P9}) / \text{Maximal}(L_{P1}:L_{P9}) * 100\%$

6.6.3. Transmittance = $L_v \text{ on LCD} / L_v \text{ on Backlight} * 100\%$

Note: Measuring machine: BM-7

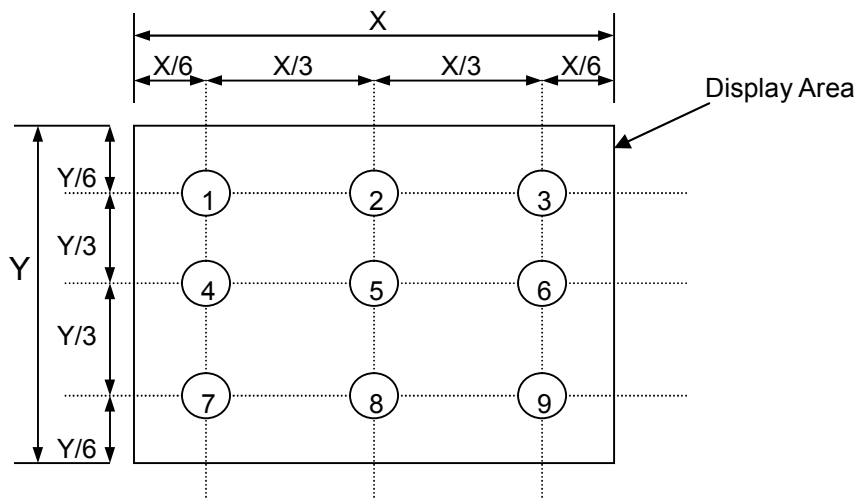

7. Block Diagram and Power Supply

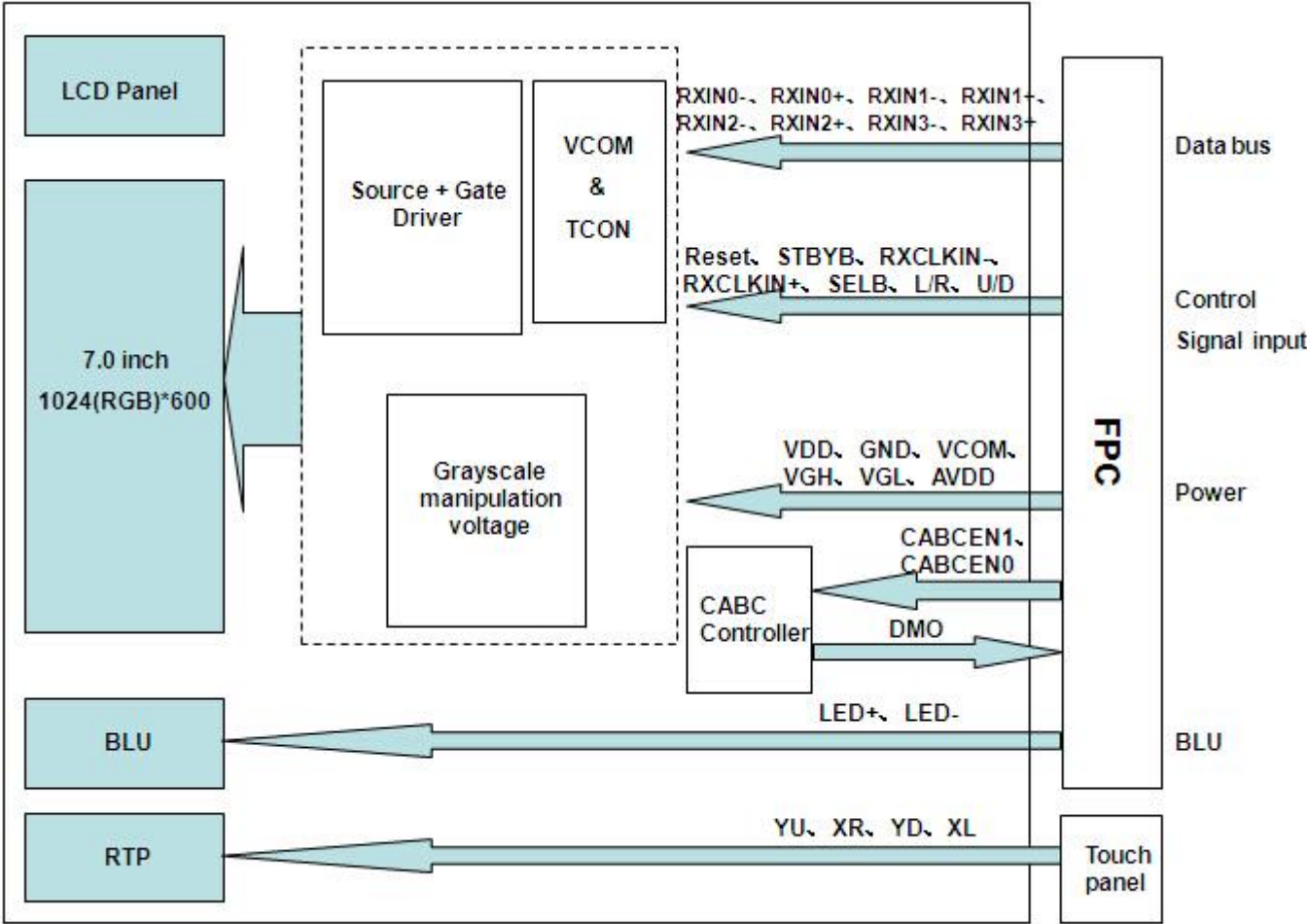

8. Interface Pins Definition

No.	Symbol	Function	Remark
1	VCOM	Common Voltage.	
2	VDD	Power Voltage for digital circuit.	
3	VDD	Power Voltage for digital circuit.	
4	NC	No connection.	
5	Reset	Global reset pin.	
6	STBYB	Standby mode Normally pulled high. STBYB="1", normal operation. STBYB="0", timing controller, source driver will turn off, all output are High-Z.	
7	GND	Ground.	
8	RXIN0-	-LVDS differential data input.	
9	RXIN0+	+LVDS differential data input.	
10	GND	Ground.	
11	RXIN1-	-LVDS differential data input.	
12	RXIN1+	+LVDS differential data input.	
13	GND	Ground.	
14	RXIN2-	-LVDS differential data input.	
15	RXIN2+	+LVDS differential data input.	
16	GND	Ground.	
17	RXCLKIN-	-LVDS differential clock input.	
18	RXCLKIN+	+LVDS differential clock input.	
19	GND	Ground.	
20	RXIN3-	-LVDS differential data input.	
21	RXIN3+	+LVDS differential data input.	
22	GND	Ground.	
23	NC	No connection.	
24	NC	No connection.	
25	GND	Ground.	
26	NC	No connection.	
27	DIMO	Backlight CABC controller signal output.	
28	SELB	6bit/8bit mode select.	Note 1
29	AVDD	Power for Analog Circuit.	
30	GND	Ground.	
31	LED-	LED Cathode.	
32	LED-	LED Cathode.	
33	L/R	Horizontal inversion.	Note 3
34	U/D	Vertical inversion.	Note 3
35	VGL	Gate OFF Voltage.	
36	CABCEN1	CABC H/W enables.	Note 2
37	CABCEN0	CABC H/W enables.	Note 2
38	VGH	Gate ON Voltage.	

39	LED+	LED Anode.	
40	LED+	LED Anode.	

Note 1: If LVDS input data is 6 bits, SELB must be set to High.

If LVDS input data is 8 bits, SELB must be set to Low.

Note 2: When CABC_EN="00", CABC OFF.

When CABC_EN="01", user interface image.

When CABC_EN="10", still picture.

When CABC_EN="11", moving image.

Note 3: When L/R="0", set right to left scan direction.

When L/R="1", set left to right scan direction.

When U/D="0", set top to bottom scan direction.

When U/D="1", set bottom to top scan direction.

TP PIN Assignment

No.	Symbol	Function	Remark
1	YU	Touch panel terminal.	
2	XL	Touch panel terminal.	
3	YD	Touch panel terminal.	
4	XR	Touch panel terminal.	

9. Timing Characteristics

9.1 AC Electrical Characteristics

Parameter	Symbol	Values			Unit	Remark
		Min.	Typ.	Max.		
Clock frequency	R_{XFCLK}	40.8	51.2	67.2	MHz	
Input data skew margin	T_{RSKM}	500	-	-	ps	
Clock high time	T_{LVCH}	-	$4/(7 * R_{XFCLK})$	-	ns	
Clock low time	T_{LVCL}	-	$3/(7 * R_{XFCLK})$	-	ns	

9.2 Input Clock and Data Timing Diagram

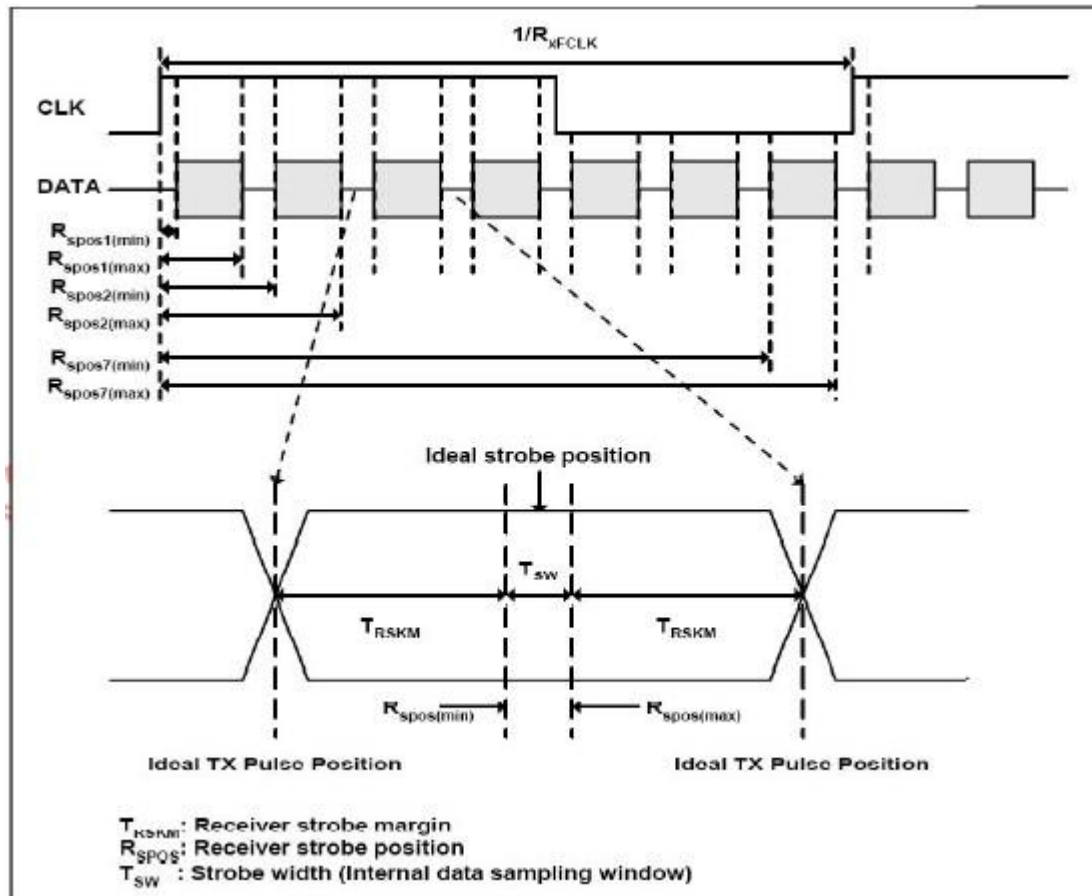
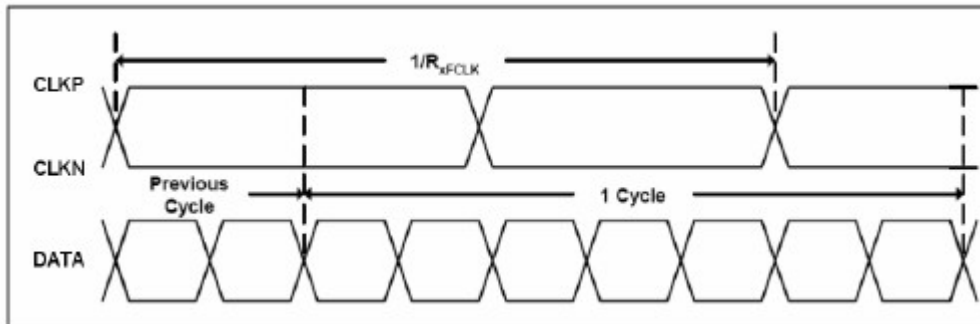

9.3 DC Electrical Characteristics

Parameter	Symbol	Values			Unit	Remark
		Min.	Typ.	Max.		
Differential input high Threshold voltage	R_{xVTH}	-	-	+0.1	V	$R_{xVCM}=1.2V$
Differential input low Threshold voltage	R_{xVTL}	-0.1	-	-	V	
Input voltage range (singled-end)	R_{xVIN}	0	-	2.4	V	
Differential input common mode voltage	R_{xVCM}	$ V_{ID} /2$	-	$2.4- V_{ID} /2$	V	
Differential voltage	$ V_{ID} $	0.2	-	0.6	V	
Differential input leakage current	$R_{V_{xIz}}$	-10	-	+10	μA	

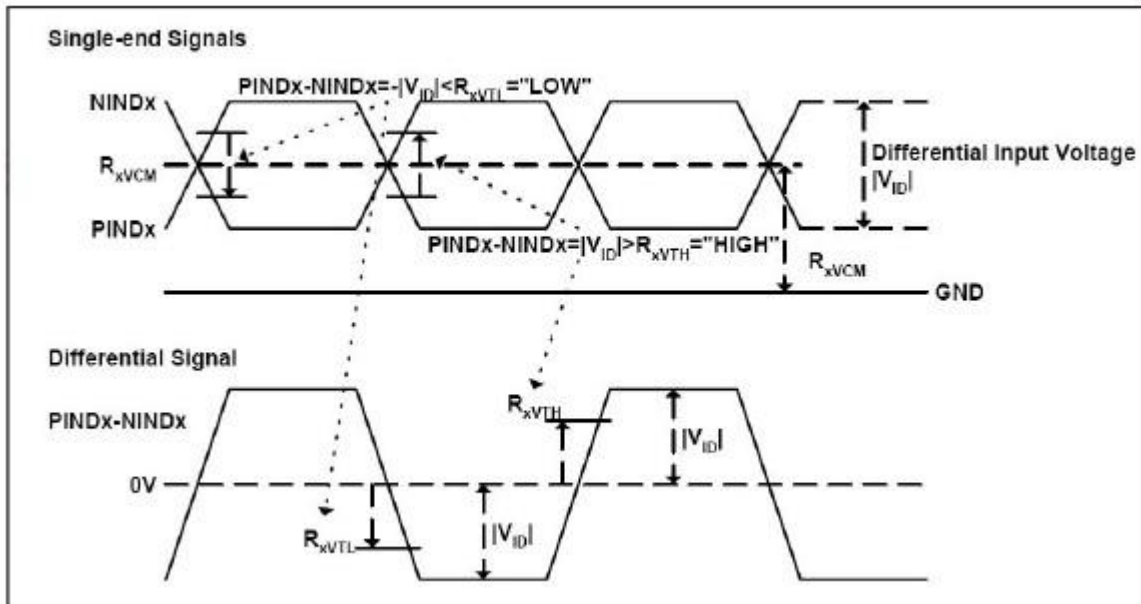

9.4 Timing

Item	Symbol	Values			Unit	Remark
		Min.	Typ.	Max.		
Clock Frequency	fclk	40.8	51.2	67.2	MHz	Frame rate =60Hz
Horizontal display area	thd	1024			DCLK	
HS period time	th	1114	1344	1400	DCLK	
HS Blanking	thb	90	320	376	DCLK	
Vertical display area	tvd	600			H	
VS period time	tv	610	635	800	H	
VS Blanking	thb	10	35	200	H	

9.5 Data Input Format

6bit LVDS input

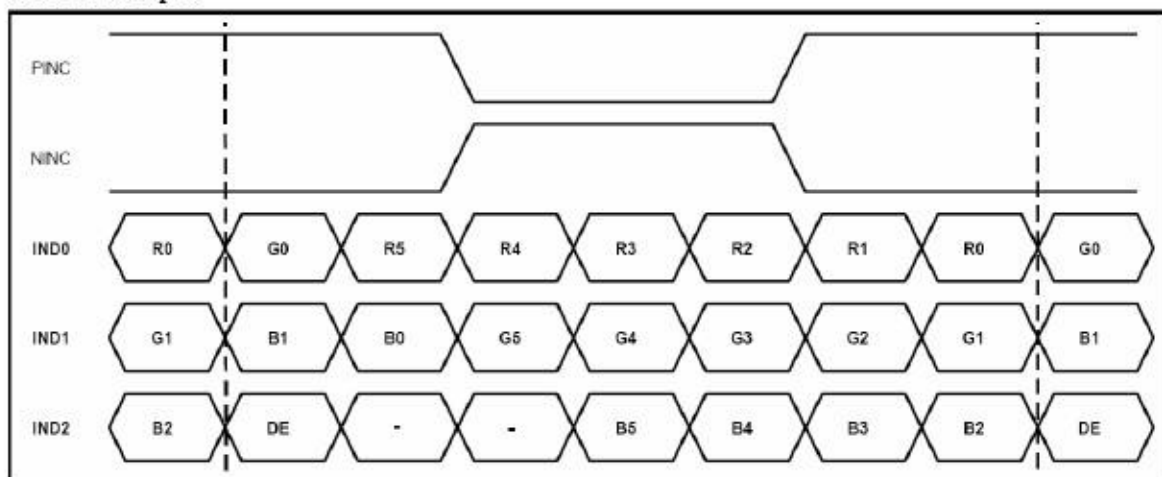

8bit LVDS input

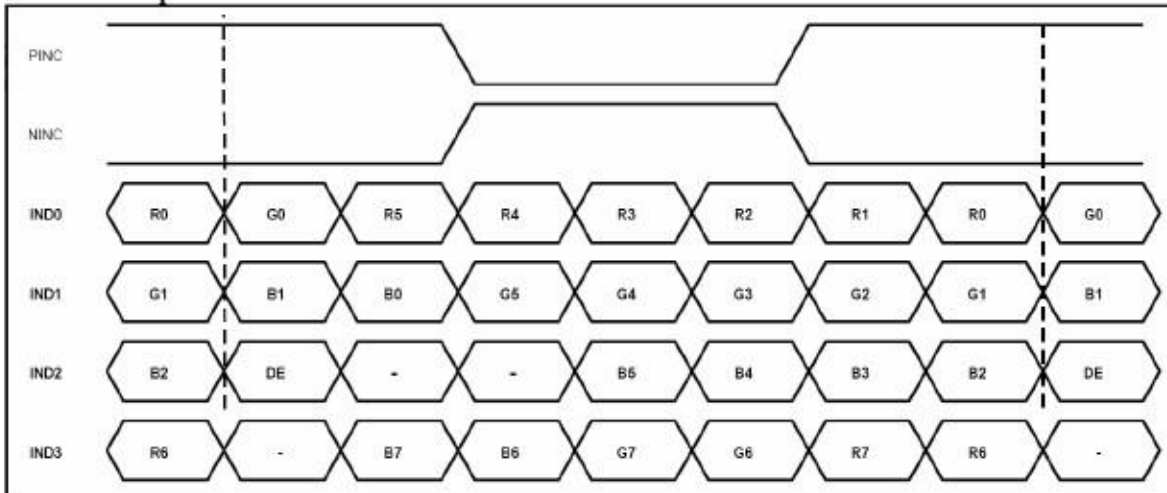

Note: Support DE timing mode only, SYNC mode not supported.

10. Power Sequence

a. Power on:

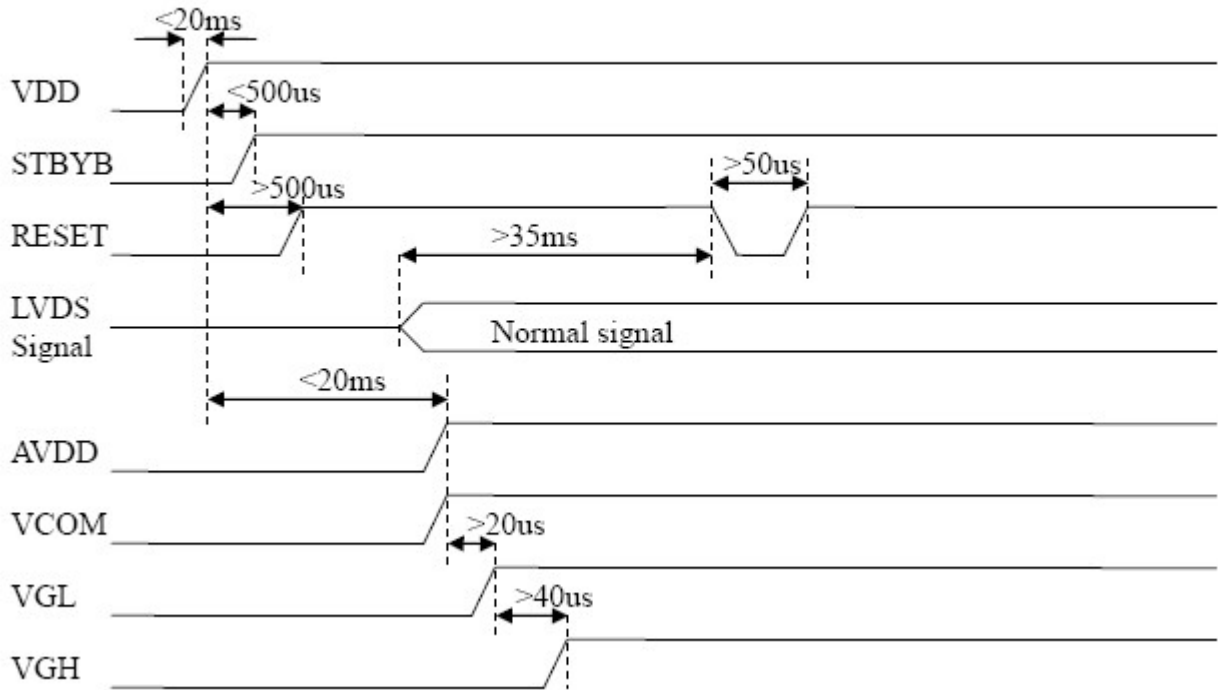

b. Power off:

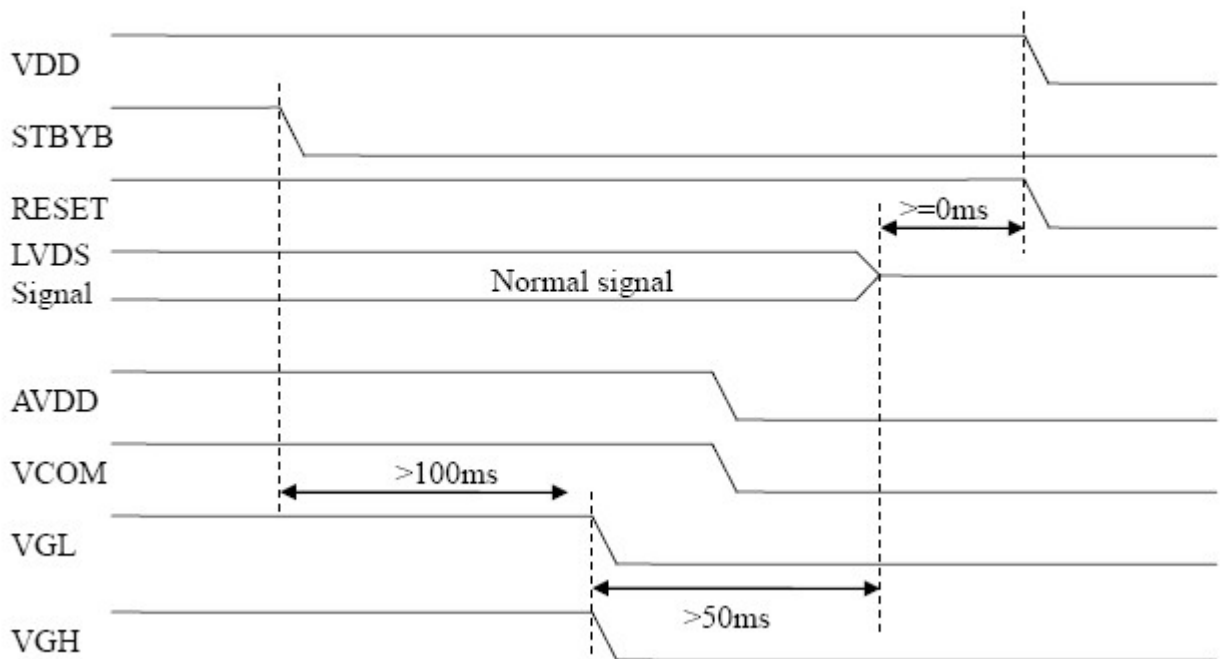

11. Quality Assurance

11.1 Purpose

This standard for Quality Assurance assures the quality of LCD module products supplied to customer.

11.2 Standard for Quality Test

11.2.1 Sampling Plan:

GB2828.1-2012

Single sampling, general inspection level II.

11.2.2 Sampling Criteria:

Visual inspection: AQL 1.5%

Electrical functional: AQL 0.65%.

11.2.3 Reliability Test:

Detailed requirement refer to Reliability Test Specification.

11.3 Nonconforming Analysis & Disposition

11.3.1 Nonconforming analysis:

11.3.1.1 Customer should provide overall information of non-conforming sample for their complaints.

11.3.1.2 After receipt of detailed information from customer, the analysis of nonconforming parts usually should be finished in one week.

11.3.1.3 If cannot finish the analysis on time, customer will be notified with the progress status.

11.3.2 Disposition of nonconforming:

11.3.2.1 Non-conforming product over PPM level will be replaced.

11.3.2.2 The cause of non-conformance will be analyzed. Corrective action will be discussed and implemented.

11.4 Agreement Items

Shall negotiate with customer if the following situation occurs:

11.4.1 There is any discrepancy in standard of quality assurance.

11.4.2 Additional requirement to be added in product specification.

11.4.3 Any other special problem.

11.5 Standard of the Product Visual Inspection

11.5.1 Appearance inspection:

11.5.1.1 The inspection must be under illumination about 1000 – 1500 lx, and the distance of view must be at 30cm ± 2cm.

11.5.1.2 The viewing angle should be 45° from the vertical line without reflection light or follows customer's viewing angle specifications.

11.5.1.3 Definition of area: A Zone: Active Area, B Zone: Viewing Area,

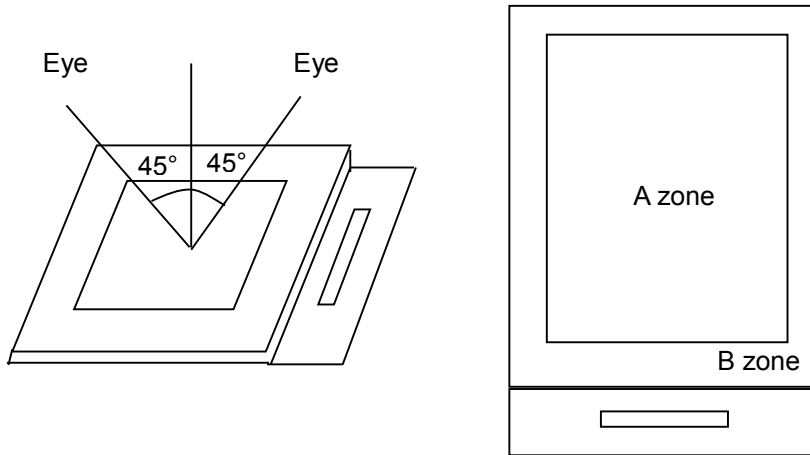

11.5.2 Basic principle:

11.5.2.1 A set of sample to indicate the limit of acceptable quality level must be discussed by both us and customer when there is any dispute happened.

11.5.2.2 New item must be added on time when it is necessary.

11.6 Inspection Specification for the TFT module

No.	Item	Criteria (Unit: mm)										
01	Black / White spot Foreign material (Round type) Pinholes Stain Particles inside cell. (Minor defect)	<p>$\phi = (a + b) / 2$</p> <p>Distance between 2 defects should more than 5mm apart.</p>										
		<table border="1"> <thead> <tr> <th>Size</th> <th>Area</th> <th>Acc. Qty</th> </tr> </thead> <tbody> <tr> <td>$\phi \leq 0.20$</td> <td></td> <td>Ignore</td> </tr> <tr> <td>$0.20 < \phi \leq 0.50$</td> <td></td> <td>$N \leq 3$</td> </tr> <tr> <td>$0.50 < \phi$</td> <td></td> <td>0</td> </tr> </tbody> </table>	Size	Area	Acc. Qty	$\phi \leq 0.20$		Ignore	$0.20 < \phi \leq 0.50$		$N \leq 3$	$0.50 < \phi$
Size	Area	Acc. Qty										
$\phi \leq 0.20$		Ignore										
$0.20 < \phi \leq 0.50$		$N \leq 3$										
$0.50 < \phi$		0										

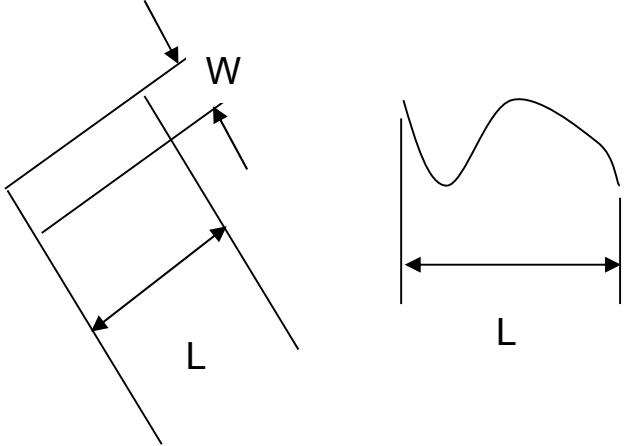
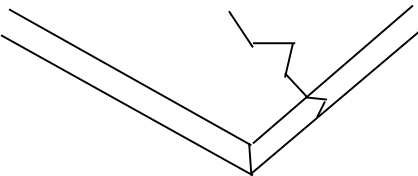
02	Electrical Defect (Minor defect)	<table border="1" data-bbox="549 226 1412 443"> <tr> <th data-bbox="549 226 858 309">Bright dot</th> <th data-bbox="858 226 1070 309">Display Area</th> <th data-bbox="1070 226 1283 309">Total</th> <th data-bbox="1283 226 1412 398" rowspan="3">Note1</th> </tr> <tr> <td data-bbox="549 309 858 353"></td> <td data-bbox="858 309 1070 353">$N \leq 2$</td> <td data-bbox="1070 309 1283 353">$N \leq 2$</td> </tr> <tr> <td data-bbox="549 353 858 398">Dark dot</td> <td data-bbox="858 353 1070 398">$N \leq 4$</td> <td data-bbox="1070 353 1283 398">$N \leq 4$</td> </tr> <tr> <td data-bbox="549 398 858 443">Total dot</td> <td data-bbox="858 398 1070 443">$N \leq 4$</td> <td data-bbox="1070 398 1283 443">$N \leq 4$</td> <td data-bbox="1283 398 1412 443" rowspan="2">Note 2</td> </tr> <tr> <td data-bbox="549 443 858 488">Mura</td> <td colspan="2" data-bbox="858 443 1283 488">Not visible through 5% ND filters.</td> </tr> </table> <p data-bbox="549 454 651 483">Remark:</p> <p data-bbox="549 492 1358 521">1. Bright dot caused by scratch and foreign object accords to item 1.</p>	Bright dot	Display Area	Total	Note1		$N \leq 2$	$N \leq 2$	Dark dot	$N \leq 4$	$N \leq 4$	Total dot	$N \leq 4$	$N \leq 4$	Note 2	Mura	Not visible through 5% ND filters.	
Bright dot	Display Area	Total	Note1																
	$N \leq 2$	$N \leq 2$																	
Dark dot	$N \leq 4$	$N \leq 4$																	
Total dot	$N \leq 4$	$N \leq 4$	Note 2																
Mura	Not visible through 5% ND filters.																		
03	Black and White line Scratch Foreign material (Line type) (Minor defect)	 <table border="1" data-bbox="608 1066 1235 1330"> <thead> <tr> <th data-bbox="608 1066 783 1155">Length</th> <th data-bbox="783 1066 1091 1155">Width</th> <th data-bbox="1091 1066 1235 1155">Acc. Qty</th> </tr> </thead> <tbody> <tr> <td data-bbox="608 1155 783 1200">/</td> <td data-bbox="783 1155 1091 1200">$W \leq 0.1$</td> <td data-bbox="1091 1155 1235 1200">Ignore</td> </tr> <tr> <td data-bbox="608 1200 783 1245">$L \leq 2.5$</td> <td data-bbox="783 1200 1091 1245">$0.1 < W \leq 0.2$</td> <td data-bbox="1091 1200 1235 1245">3</td> </tr> <tr> <td data-bbox="608 1245 783 1290">$L > 2.5$</td> <td data-bbox="783 1245 1091 1290">$0.2 < W$</td> <td data-bbox="1091 1245 1235 1290">0</td> </tr> <tr> <td colspan="2" data-bbox="608 1290 1091 1330">Total</td> <td data-bbox="1091 1290 1235 1330">3</td> </tr> </tbody> </table> <p data-bbox="549 1375 1417 1447">Distance between 2 defects should more than 3mm apart. Scratches not viewable through the back of the display are acceptable.</p>	Length	Width	Acc. Qty	/	$W \leq 0.1$	Ignore	$L \leq 2.5$	$0.1 < W \leq 0.2$	3	$L > 2.5$	$0.2 < W$	0	Total		3		
Length	Width	Acc. Qty																	
/	$W \leq 0.1$	Ignore																	
$L \leq 2.5$	$0.1 < W \leq 0.2$	3																	
$L > 2.5$	$0.2 < W$	0																	
Total		3																	
04	Glass Crack (Minor defect)	 <p data-bbox="549 1749 1177 1783">Crack is potential to enlarge, any type is not allowed.</p>																	

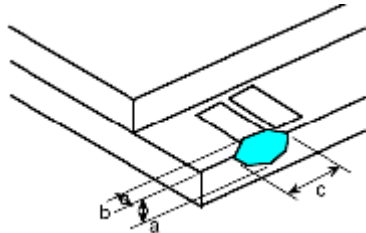
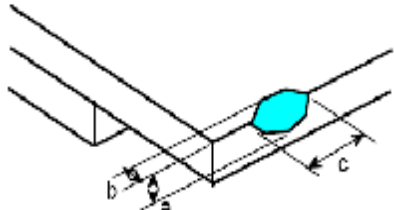
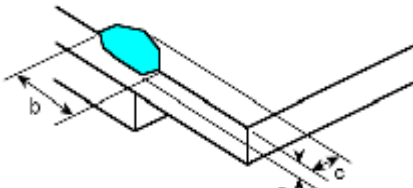
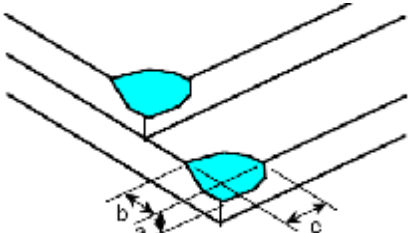
<p>05</p>	<p>Glass Chipping Pad Area: (Minor defect)</p> 	<table border="1"> <thead> <tr> <th>Length and Width</th> <th>Acc. Qty</th> </tr> </thead> <tbody> <tr> <td>$c > 3.0, b < 1.0$</td> <td>1</td> </tr> <tr> <td>$c < 3.0, b < 1.0$</td> <td>3</td> </tr> <tr> <td colspan="2" style="text-align: center;">$a < \text{Glass Thickness}$</td> </tr> </tbody> </table>	Length and Width	Acc. Qty	$c > 3.0, b < 1.0$	1	$c < 3.0, b < 1.0$	3	$a < \text{Glass Thickness}$			
Length and Width	Acc. Qty											
$c > 3.0, b < 1.0$	1											
$c < 3.0, b < 1.0$	3											
$a < \text{Glass Thickness}$												
<p>06</p>	<p>Glass Chipping Rear of Pad Area: (Minor defect)</p> 	<table border="1"> <thead> <tr> <th>Length and Width</th> <th>Acc. Qty</th> </tr> </thead> <tbody> <tr> <td>$c > 3.0, b < 1.0$</td> <td>1</td> </tr> <tr> <td>$c < 3.0, b < 1.0$</td> <td>2</td> </tr> <tr> <td>$c < 3.0, b < 0.5$</td> <td>4</td> </tr> <tr> <td colspan="2" style="text-align: center;">$a < \text{Glass Thickness}$</td> </tr> </tbody> </table>	Length and Width	Acc. Qty	$c > 3.0, b < 1.0$	1	$c < 3.0, b < 1.0$	2	$c < 3.0, b < 0.5$	4	$a < \text{Glass Thickness}$	
Length and Width	Acc. Qty											
$c > 3.0, b < 1.0$	1											
$c < 3.0, b < 1.0$	2											
$c < 3.0, b < 0.5$	4											
$a < \text{Glass Thickness}$												
<p>07</p>	<p>Glass Chipping Except Pad Area: (Minor defect)</p> 	<table border="1"> <thead> <tr> <th>Length and Width</th> <th>Acc. Qty</th> </tr> </thead> <tbody> <tr> <td>$c > 3.0, b < 1.0$</td> <td>1</td> </tr> <tr> <td>$c < 3.0, b < 1.0$</td> <td>2</td> </tr> <tr> <td>$c < 3.0, b < 0.5$</td> <td>4</td> </tr> <tr> <td colspan="2" style="text-align: center;">$a < \text{Glass Thickness}$</td> </tr> </tbody> </table>	Length and Width	Acc. Qty	$c > 3.0, b < 1.0$	1	$c < 3.0, b < 1.0$	2	$c < 3.0, b < 0.5$	4	$a < \text{Glass Thickness}$	
Length and Width	Acc. Qty											
$c > 3.0, b < 1.0$	1											
$c < 3.0, b < 1.0$	2											
$c < 3.0, b < 0.5$	4											
$a < \text{Glass Thickness}$												
<p>08</p>	<p>Glass Corner Chipping: (Minor defect)</p> 	<table border="1"> <thead> <tr> <th>Length and Width</th> <th>Acc. Qty</th> </tr> </thead> <tbody> <tr> <td>$c < 3.0, b < 3.0$</td> <td>Ignore</td> </tr> <tr> <td colspan="2" style="text-align: center;">$a < \text{Glass Thickness}$</td> </tr> </tbody> </table>	Length and Width	Acc. Qty	$c < 3.0, b < 3.0$	Ignore	$a < \text{Glass Thickness}$					
Length and Width	Acc. Qty											
$c < 3.0, b < 3.0$	Ignore											
$a < \text{Glass Thickness}$												

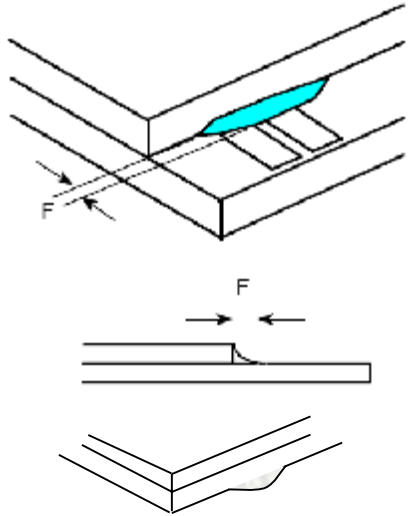
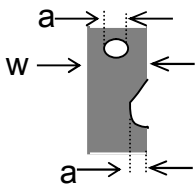
<p>09</p>	<p>Glass Burr: (Minor defect)</p> 	<table border="1" data-bbox="858 264 1332 353"> <thead> <tr> <th>Length</th> <th>Acc. Qty</th> </tr> </thead> <tbody> <tr> <td>$F < 1.0$</td> <td>Ignore</td> </tr> </tbody> </table> <p>Glass burr don't affect assemble and module dimension.</p>	Length	Acc. Qty	$F < 1.0$	Ignore				
Length	Acc. Qty									
$F < 1.0$	Ignore									
<p>10</p>	<p>FPC Defect: (Minor defect)</p> 	<p>10.1 Dent, pinhole width $a < w/3$. (w: circuitry width.)</p> <p>10.2 Open circuit is unacceptable.</p> <p>10.3 No oxidation, contamination and distortion.</p>								
<p>11</p>	<p>Bubble on Polarizer (Minor defect)</p>	<table border="1" data-bbox="735 1339 1206 1512"> <thead> <tr> <th>Diameter</th> <th>Acc. Qty</th> </tr> </thead> <tbody> <tr> <td>$\varphi \leq 0.30$</td> <td>Ignore</td> </tr> <tr> <td>$0.30 < \varphi \leq 0.50$</td> <td>$N \leq 2$</td> </tr> <tr> <td>$0.50 < \varphi$</td> <td>$N = 0$</td> </tr> </tbody> </table>	Diameter	Acc. Qty	$\varphi \leq 0.30$	Ignore	$0.30 < \varphi \leq 0.50$	$N \leq 2$	$0.50 < \varphi$	$N = 0$
Diameter	Acc. Qty									
$\varphi \leq 0.30$	Ignore									
$0.30 < \varphi \leq 0.50$	$N \leq 2$									
$0.50 < \varphi$	$N = 0$									
<p>12</p>	<p>Dent on Polarizer (Minor defect)</p>	<table border="1" data-bbox="735 1585 1206 1758"> <thead> <tr> <th>Diameter</th> <th>Acc. Qty</th> </tr> </thead> <tbody> <tr> <td>$\varphi \leq 0.25$</td> <td>Ignore</td> </tr> <tr> <td>$0.25 < \varphi \leq 0.50$</td> <td>$N \leq 4$</td> </tr> <tr> <td>$0.50 < \varphi$</td> <td>None</td> </tr> </tbody> </table>	Diameter	Acc. Qty	$\varphi \leq 0.25$	Ignore	$0.25 < \varphi \leq 0.50$	$N \leq 4$	$0.50 < \varphi$	None
Diameter	Acc. Qty									
$\varphi \leq 0.25$	Ignore									
$0.25 < \varphi \leq 0.50$	$N \leq 4$									
$0.50 < \varphi$	None									
<p>13</p>	<p>Bezel</p>	<p>13.1 No rust, distortion on the Bezel.</p> <p>13.2 No visible fingerprints, stains or other contamination.</p>								

14	Touch Panel	<p>D: Diameter W: width L: length</p> <p>14.1 Spot: $D < 0.25$ is acceptable $0.25 \leq D \leq 0.4$</p> <p>2dots are acceptable and the distance between defects should more than 10 mm.</p> <p>$D > 0.4$ is unacceptable</p> <p>14.2 Dent: $D > 0.40$ is unacceptable</p> <p>14.3 Scratch: $W \leq 0.03$, $L \leq 10$ is acceptable, $0.03 < W \leq 0.10$, $L \leq 10$ is acceptable</p> <p>Distance between 2 defects should more than 10 mm. $W > 0.10$ is unacceptable.</p>
15	PCB	<p>15.1 No distortion or contamination on PCB terminals.</p> <p>15.2 All components on PCB must same as documented on the BOM/component layout.</p> <p>15.3 Follow IPC-A-600F.</p>
16	Soldering	Follow IPC-A-610C standard
17	Electrical Defect (Major defect)	<p>The below defects must be rejected.</p> <p>17.1 Missing vertical / horizontal segment,</p> <p>17.2 Abnormal Display.</p> <p>17.3 No function or no display.</p> <p>17.4 Current exceeds product specifications.</p> <p>17.5 LCD viewing angle defect.</p> <p>17.6 No Backlight.</p> <p>17.7 Dark Backlight.</p> <p>17.8 Touch Panel no function.</p>

Remark: LCD Panel Broken shall be rejected. Defect out of LCD viewing area is acceptable.

11.8 Classification of Defects

11.8.1 Visual defects (Except no / wrong label) are treated as minor defect and electrical defect is major.

11.8.2 Two minor defects are equal to one major in lot sampling inspection.

11.9 Identification/marketing criteria

Any unit with illegible / wrong /double or no marking/ label shall be rejected.

11.10 Packaging

11.10.1 There should be no damage of the outside carton box, each packaging box should have one identical label.

11.10.2 Modules inside package box should have compliant mark.

11.10.3 All direct package materials shall offer ESD protection

Note1: Bright dot is defined as the defective area of the dot is larger than 50% of one sub-pixel area.

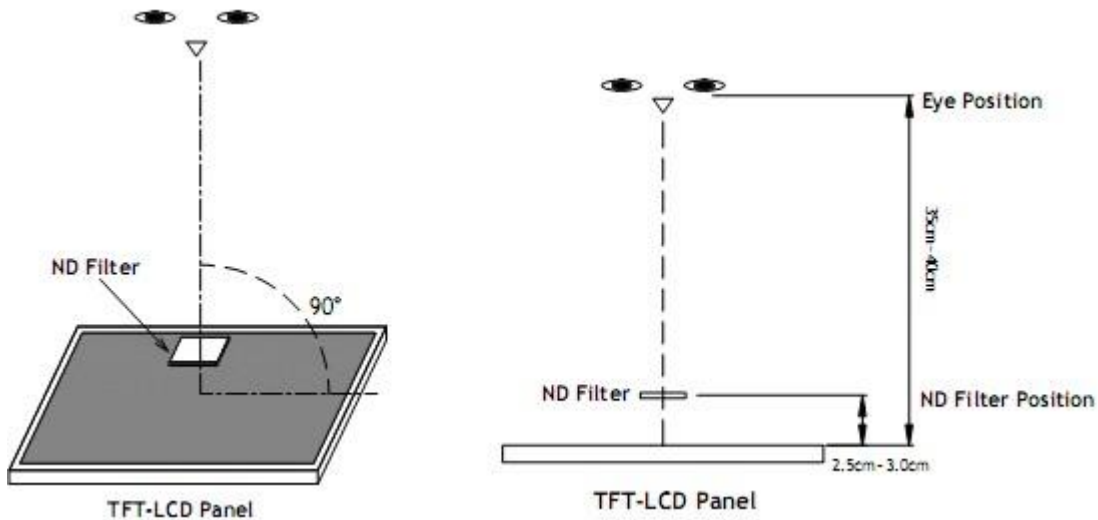

Bright dot: The bright dot size defect at black display pattern. It can be recognized by 2% transparency of filter when the distance between eyes and panel is 350mm±50mm.

Dark dot: Cyan, Magenta or Yellow dot size defect at white display pattern. It can be recognized by 5% transparency of filter when the distance between eyes and panel is 350mm±50mm.

Note2: Mura on display which appears darker / brighter against background brightness on parts of display area.

12. Reliability Specification

No	Item	Condition	Quantity	Criteria
1	High Temperature Operating	70°C, 96Hrs	2	GB/T2423.2-2008
2	Low Temperature Operating	-20°C, 96Hrs	2	GB/T2423.1-2008
3	High Humidity	50°C, 90%RH, 96Hrs	2	GB/T2423.3-2006
4	High Temperature Storage	80°C, 96Hrs	2	GB/T2423.2-2008
5	Low Temperature Storage	-30°C, 96Hrs	2	GB/T2423.1-2008
6	Thermal Cycling Test	-20° C, 60min~70° C, 60min, 20 cycles.	2	GB/T2423.22-2012
7	Packing vibration	Frequency range:10Hz~50Hz Acceleration of gravity:5G X, Y, Z 30 min for each direction.	2	GB/T5170.14-2009
8	Electrical Static Discharge	Air: ±8KV 150pF/330Ω 5 times	2	GB/T17626.2-2006
		Contact: ±4KV 150pF/330Ω 5 times		
9	Drop Test (Packaged)	Height:80 cm,1 corner, 3 edges, 6 surfaces.	2	GB/T2423.8-1995

Note1. No deflection cosmetic and operational function allowable.

Note2. Total current Consumption should be below double of initial value

13. Precautions and Warranty

13.1 Safety

13.1.1 The liquid crystal in the LCD is poisonous. Do not put it in your mouth. If the liquid crystal touches your skin or clothes, wash it off immediately using soap and water.

13.1.2 Since the liquid crystal cells are made of glass, do not apply strong impact on them. Handle with care.

13.2 Handling

13.2.1 Reverse and use within ratings in order to keep performance and prevent damage.

13.2.2 Do not wipe the polarizer with dry cloth, as it might cause scratch. If the surface of the LCD needs to be cleaned, wipe it swiftly with cotton or other soft cloth soaked with petroleum IPA, do not use other chemicals.

13.3 Storage

13.3.1 Do not store the LCD module beyond the specified temperature ranges.

13.4 Metal Pin (Apply to Products with Metal Pins)

13.4.1 Pins of LCD and Backlight

13.4.1.1 Solder tip can touch and press on the tip of Pin LEAD during the soldering

13.4.1.2 Recommended Soldering Conditions

Solder Type: Sn96.3~94-Ag3.3~4.3-Cu0.4~1.1

Maximum Solder Temperature: 370° C

Maximum Solder Time: 3s at the maximum temperature

Recommended Soldering Temp: 350±20° C

Typical Soldering Time: ≤3s

13.4.1.3 Solder Wetting

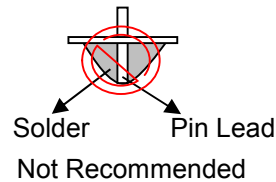
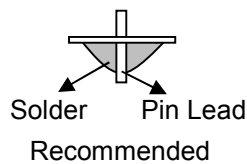

13.4.2 Pins of EL

13.4.2.1 Solder tip can touch and press on the tip of EL leads during soldering.

13.4.2.2 No Solder Paste on the soldering pad on the motherboard is recommended.

13.4.2.3 Recommended Soldering Conditions

Solder type: Nippon Alimit Leadfree SR-34, size 0.5mm

Recommended Solder Temperature: 270~290° C

Typical Soldering Time: ≤2s

Minimum solder distance from EL lamp (body):2.0mm

13.4.2.4 No horizontal press on the EL leads during soldering.

13.4.2.5 180° bend EL leads three times is not allowed.

13.4.2.6 Solder Wetting

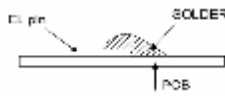

Recommended

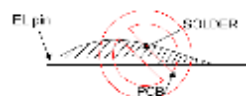

Not Recommended

13.4.2.7 The type of the solder iron:

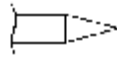

Recommended

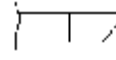

Not Recommended

13.4.2.8 Solder Pad

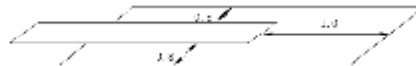

13.5 Operation

- 13.5.1 Do not drive LCD with DC voltage
- 13.5.2 Response time will increase below lower temperature
- 13.5.3 Display may change color with different temperature
- 13.5.4 Mechanical disturbance during operation, such as pressing on the display area, may cause the segments to appear “fractured”.

13.6 Static Electricity

- 13.6.1 CMOS LSIs are equipped in this unit, so care must be taken to avoid the electro-static charge, by ground human body, etc.
- 13.6.2 The normal static prevention measures should be observed for work clothes and benches.
- 13.6.3 The module should be kept into anti-static bags or other containers resistant to static for storage.

13.7 Limited Warranty

- 13.7.1 Our warranty liability is limited to repair and/or replacement. We will not be responsible for any consequential loss.
- 13.7.2 If possible, we suggest customer to use up all modules in six months. If the module storage time over twelve months, we suggest that recheck it before the module be used.
- 13.7.3 After the product shipped, any product quality issues must be feedback within three months, otherwise, we will not be responsible for the subsequent or consequential events.

14. Outline Drawing

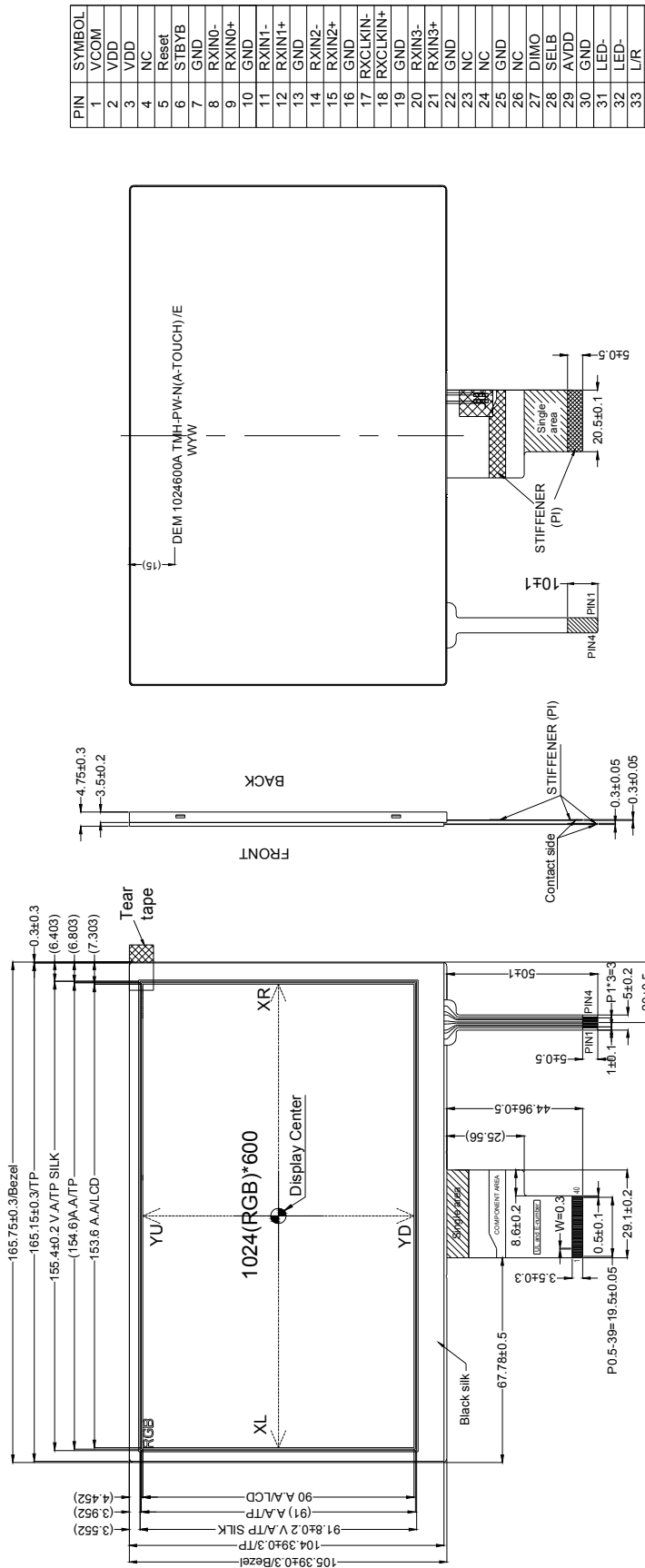

PIN	SYMBOL
1	VCOM
2	VDD
3	VDD
4	NC
5	Reset
6	STRBYB
7	GND
8	RXIND-
9	RXIND+
10	GND
11	RXIN1-
12	RXIN1+
13	GND
14	RXIN2-
15	RXIN2+
16	GND
17	RXCLKIN-
18	RXCLKIN+
19	GND
20	RXIN3-
21	RXIN3+
22	GND
23	NC
24	NC
25	GND
26	NC
27	DIMO
28	SELB
29	AVDD
30	GND
31	LED-
32	LED-
33	L/R
34	U/D
35	VGL
36	CABEN1
37	CABEN0
38	VGH
39	LED+
40	LED+

TP/PIN Assignment

1.	YU
2.	XL
3.	YD
4.	XR

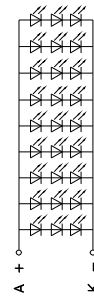

NOTES:

1. Display type: 7" TFT
 2. Viewing direction: 12 O'CLOCK
 3. Gary Scale Inversion direction: 6 O'CLOCK
 4. Polarizer mode: Transmissive/Normal white
 5. Operation temperature: -20°C ~ +70°C
 6. Storage temperature: -30°C ~ +80°C
 7. Logic power supply voltage: 3.3V
 8. Backlight : White(9.3V(Typ); 10.2V(Max) /9*20=180mA
 9. Luminance: 360 cd/m²(TYPE)
 10. ROHS must be complied
- * Unspecification tolerance are ±0.2mm