

Display Elektronik GmbH

DATA SHEET

TFT- MODULE

DEM 7201280B VRH-FW-N

5,5" refl. TFT + Frontlight

Product Specification

Ver.: 3

22.02.2024

Revision History

Revision	Date	Originator	Detail	Remarks
0	23.12.2023	LQ	Initial Release	-
1	27.01.2024	LL	Modify Interface Pins Definition Modify Outline Drawing	P10 P24
2	19.02.2024	ZYJ	Modify Optical Characteristics	P6
3	22.02.2024	ZYJ	Add Weight Add Current Consumption	P4 P5

Table of Contents

No.	Item	Page
1.	General Description	4
2.	Module Parameter	4
3.	Absolute Maximum Ratings	4
4.	DC Characteristics	5
5.	Frontlight Characteristic	5
5.1.	Frontlight Characteristic	5
5.2.	Frontlight Characteristic	5
6.	Optical Characteristics	6
6.1.	Optical Characteristics	6
6.2.	Definition of Response Time	6
6.3.	Definition of Contrast Ratio	7
6.4.	Definition of Viewing Angles	7
6.5.	Definition of Color Appearance	8
6.6.	Definition of Surface Luminance, Uniformity and Transmittance	8
7.	Block Diagram and Power Supply	9
8.	Interface Pins Definition	10
9.	AC Characteristics	11
9.1.	DSI Timing Characteristics	11
9.2.	Reset Timing	14
10.	Quality Assurance	15
10.1.	Purpose	15
10.2.	Standard for Quality Test	15
10.3.	Nonconforming Analysis & Disposition	15
10.4.	Agreement Items	15
10.5.	Standard of the Product Visual Inspection	15
10.6.	Inspection Specification	16
10.7.	Classification of Defects	20
10.8.	Identification/marketing criteria	20
10.9.	Packing	20
11.	Reliability Specification	21
12.	Precautions and Warranty	22
12.1.	Safety	22
12.2.	Handling	22
12.3.	Storage	22
12.4.	Metal Pin (Apply to Products with Metal Pins)	22
12.5.	Operation	23
12.6.	Static Electricity	23
12.7.	Limited Warranty	23
13.	Outline Drawing	24

1. General Description

The specification is a reflective type color active matrix liquid crystal display (LCD) which uses amorphous thin film transistor (TFT) as switching devices. This product is composed of a TFT-LCD panel, driver ICs and a frontlight unit.

2. Module Parameter

Features	Details	Unit
Display Size(Diagonal)	5.5"	-
Display Mode	Reflective / Normally White	-
Resolution	720 RGB x 1280	Pixels
View Direction	FULL VIEW	Best Image
Module Outline	81.44 x 132.16 x 2.30 (Note1)	mm
Active Area	68.04 x 120.96	mm
Pixel Size	0.945 x 0.945	mm
Pixel Arrangement	RGB Vertical Stripe	-
Display Colors	16.7 M	-
Interface	MIPI Interface	-
With or without touch panel	Without	-
Driver IC	ILI9881C (Ilitek)	-
Operating Temperature	-20 ~ +70	°C
Storage Temperature	-30 ~ +80	°C
Weight	16	g

Note 1: Exclusive hooks, posts, FFC/FPC tail etc.

3. Absolute Maximum Ratings

GND=0V, Ta=25°C

Item	Symbol	Min.	Max.	Unit
Supply Voltage	VCI	-0.3	7.0	V
	IOVCC	-0.3	3.8	V
Storage Temperature	T _{STG}	-30	+80	°C
Operating Temperature	T _{OP}	-20	+70	°C

Note 1: If Ta below 50°C, the maximal humidity is 90%RH, if Ta over 50°C, absolute humidity should be less than 60%RH.

Note 2: The response time will be extremely slow when the operating temperature is around -10°C, and the back ground will become darker at high temperature operating.

4. DC Characteristics

Item	Symbol	Min.	Typ.	Max.	Unit	
Supply Voltage	V _{CI}	2.5	2.8	6.6	V	
	IOVCC	1.65	1.8	3.6	V	
Logic High Level Input Voltage	V _{IH}	0.7* IOVCC	-	IOVCC	mV	
Logic Low Level Input Voltage	V _{IL}	-0.3	-	0.3* IOVCC	mV	
Logic High Level Output Voltage	V _{OH}	0.8* IOVCC	-	IOVCC	mV	
Logic Low Level Output Voltage	V _{OL}	0	-	0.2* IOVCC	mV	
Current Consumption All Black	Logic	I _{CI} + I _{IO}	-	20	-	μA
	Analog					

5. Frontlight Characteristic

5.1. Frontlight Characteristic

Item	Symbol	Condition	Min.	Typ.	Max.	Unit
Forward Voltage	V _F	Ta=25 °C, I _F =20mA/LED	14.0	16.0	18.0	V
Forward Current	I _F	Ta=25 °C, V _F =3.2V/LED	-	140	-	mA
Power Dissipation	P _D		-	2240	-	mW
Uniformity	Avg		-	80	-	%
LED Lifetime (25°C)	-	-	20,000	30,000	-	Hrs
Drive Method	Constant Current					
LED Configuration	35 White LEDs (5 LEDs in one string and 7 groups in parallel)					

Note1: LED lifetime defined as follows: The final brightness is at 50% of original brightness.

The environmental conducted under ambient air flow, at Ta=25°C±2 °C, 60%RH±5%, I_F=20mA/LED.

5.2. Frontlight Characteristic

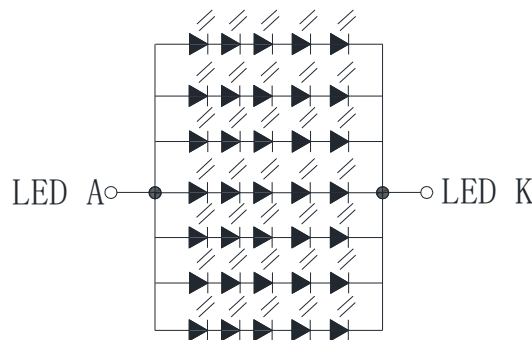

6. Optical Characteristics

6.1. Optical Characteristics

Ta=25°C, VCI=2.8V

	Item	Symbol	Condition	Specification			Unit	
				Min.	Typ.	Max.		
Frontlight On (Reflective Mode)	Luminance on TFT ($I_f = 20\text{mA/LED}$)	Lv	Normally viewing angle $\theta_X = \phi_Y = 0^\circ$	-	120	-	cd/m ²	
	Contrast Ratio (See 6.3)	CR		-	15	-		
	Response Time (See 6.2)	TR+TF		-	5	7	ms	
	Chromaticity Reflective (See 6.5)	Red	X _R	Center CR≥10	0.255	0.305	0.355	
			Y _R		0.255	0.305	0.355	
		Green	X _G		0.231	0.281	0.331	
			Y _G		0.293	0.343	0.393	
		Blue	X _B		0.195	0.245	0.295	
			Y _B		0.229	0.279	0.329	
	White	X _W	0.239	0.289	0.339			
Y _W		0.270	0.320	0.320				
Viewing Angle (See 6.4)	Horizontal	θ_{X+}	-	60	-	Deg.		
		θ_{X-}	-	60	-			
	Vertical	ϕ_{Y+}	-	60	-			
		ϕ_{Y-}	-	60	-			
NTSC Ratio (Gamut)				-	7	-	%	

6.2. Definition of Response Time

6.2.1. Normally Black Type (Negative)

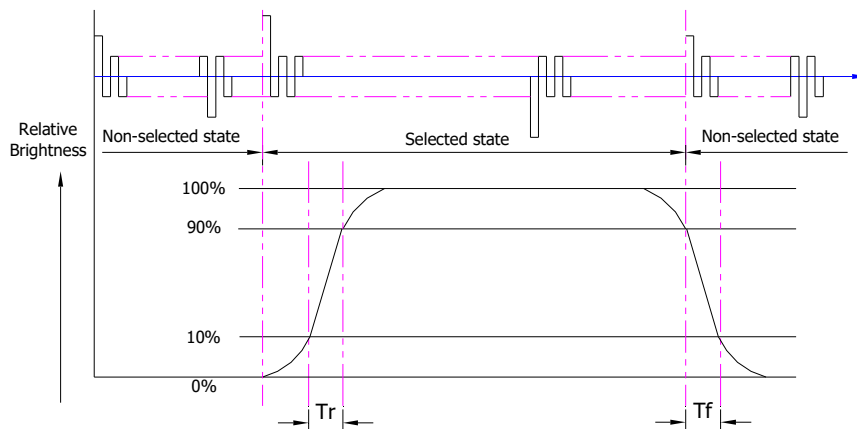

Tr is the time it takes to change from non-selected stage with relative luminance 10% to selected state with relative luminance 90%;

Tf is the time it takes to change from selected state with relative luminance 90% to

non-selected state with relative luminance 10%.

Note: Measuring machine: LCD-5100

6.2.2. Normally White Type (Positive)

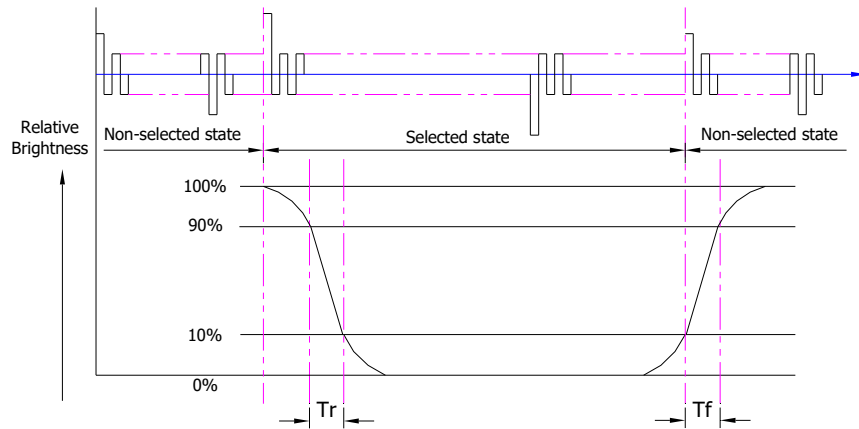

Tr is the time it takes to change from non-selected state with relative luminance 90% to selected state with relative luminance 10%;

Tf is the time it takes to change from selected state with relative luminance 10% to non-selected state with relative luminance 90%;

Note: Measuring machine: LCD-5100 or EQUI

6.3. Definition of Contrast Ratio

Contrast is measured perpendicular to display surface in reflective and reflective mode. The measurement condition is:

Measuring Equipment	Eldim or Equivalent
Measuring Point Diameter	3mm//1mm
Measuring Point Location	Active Area centre point
Test pattern	A: All Pixels white
	B: All Pixel black
Contrast setting	Maximum

Definitions: CR (Contrast) = Luminance of White Pixel / Luminance of Black Pixel

6.4. Definition of Viewing Angles

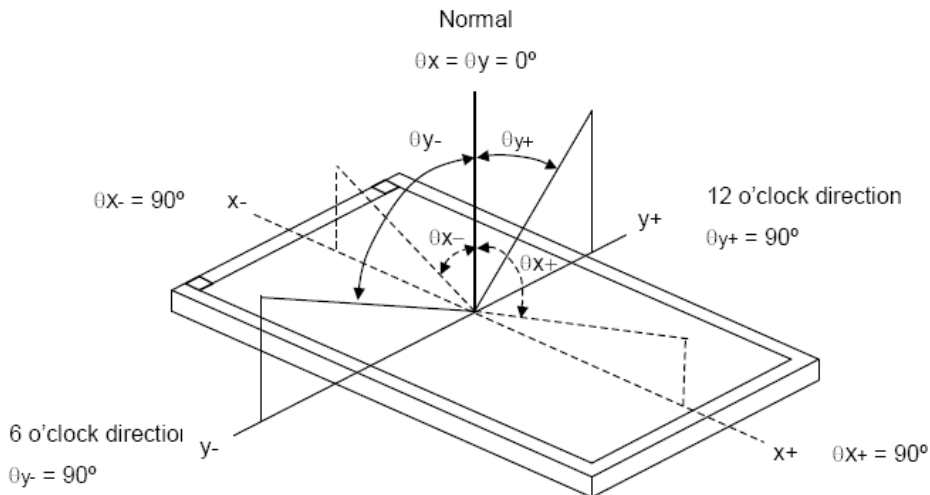

Measuring machine: LCD-5100 or EQUI

6.5. Definition of Color Appearance

R,G,B and W are defined by (x, y) on the IE chromaticity diagram

NTSC=area of RGB triangle/area of NTSC triangleX100%

Measuring picture: Red, Green, Blue and White (Measuring machine: BM-7)

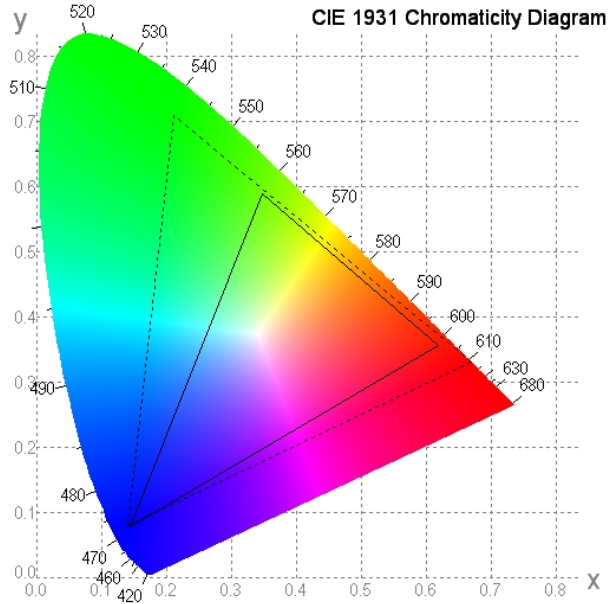

6.6. Definition of Surface Luminance, Uniformity and Transmittance

Using the reflective mode measurement approach, measure the white screen luminance of the display panel and frontlight.

6.6.1. Surface Luminance: $L_v = \text{average} (L_{P1}:L_{P9})$

6.6.2. Uniformity = $\text{Minimal} (L_{P1}:L_{P9}) / \text{Maximal} (L_{P1}:L_{P9}) * 100\%$

6.6.3. Transmittance = $L_v \text{ on LCD} / L_v \text{ on frontlight} * 100\%$

Note: Measuring machine: BM-7

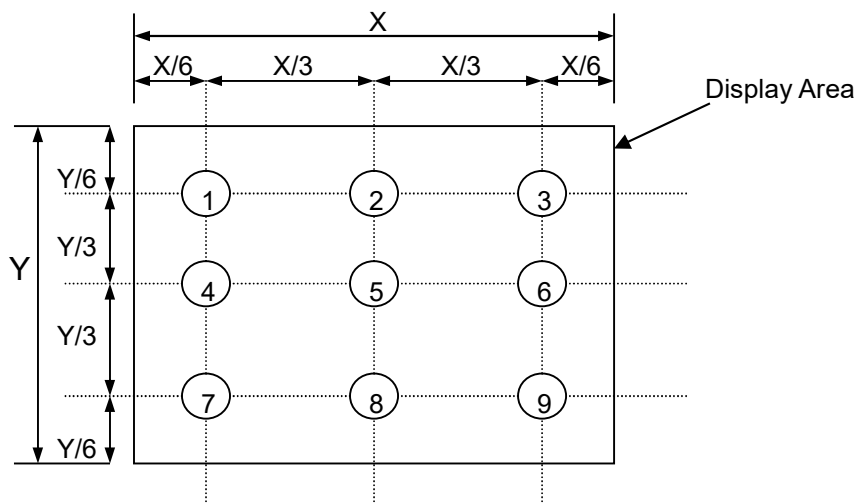

7. Block Diagram and Power Supply

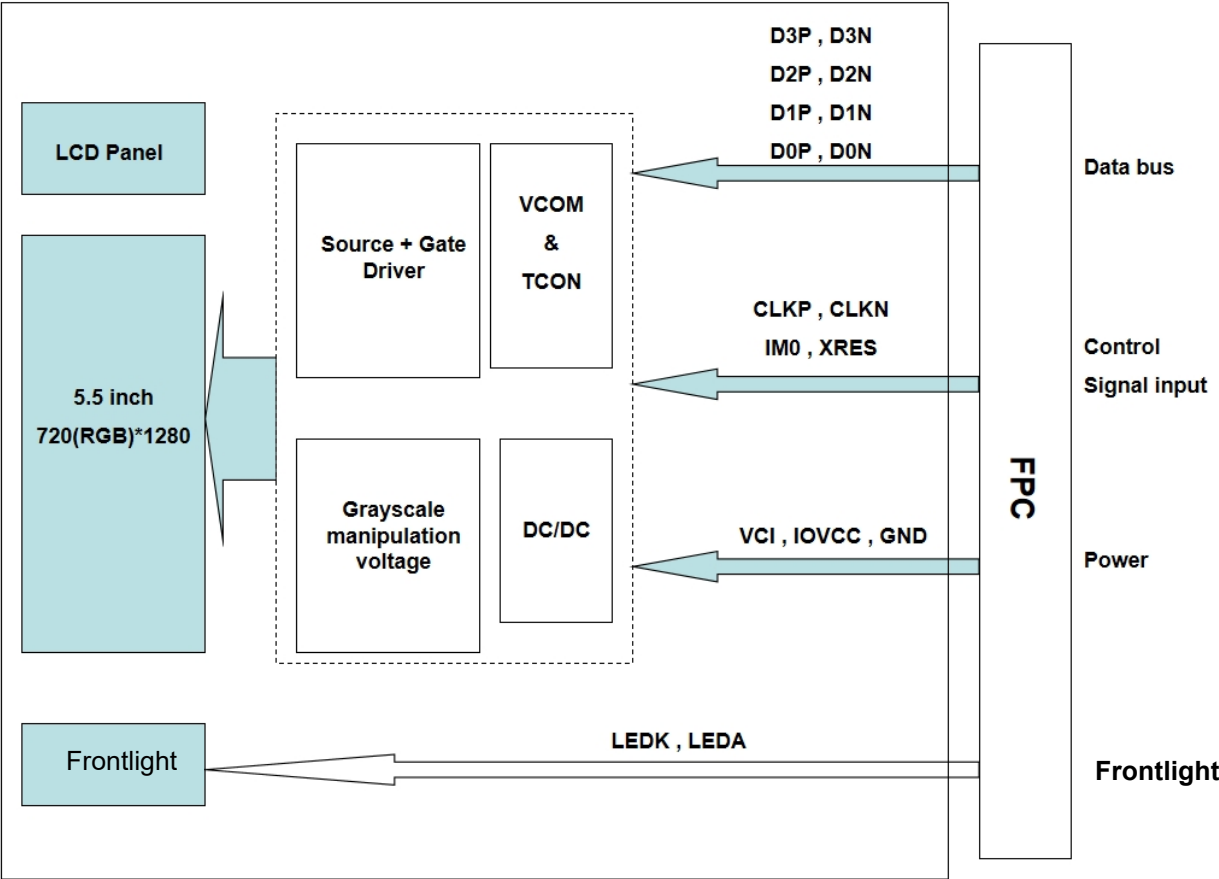

8. Interface Pins Definition

No.	Symbol	Function	Remark																																
1	MTP_PWR	Input power for OTP programming. MTP_PWR=8.5V When not under programming, let MTP_PWR float or connect to ground.																																	
2	GND	Ground																																	
3	D3N	MIPI data Input																																	
4	D3P	MIPI data Input																																	
5	GND	Ground																																	
6	D2N	MIPI data Input																																	
7	D2P	MIPI data Input																																	
8	GND	Ground																																	
9	D1N	MIPI data Input																																	
10	D1P	MIPI data Input																																	
11	GND	Ground																																	
12	D0N	MIPI data Input																																	
13	D0P	MIPI data Input																																	
14	GND	Ground																																	
15	CLKP	MIPI clock Input																																	
16	CLKN	MIPI clock Input																																	
17	GND	Ground																																	
18	NC	No connection																																	
19	NC	No connection																																	
20	NC	No connection																																	
21	IM0	Used to configure lane sequence and polarity <table border="1" style="margin-left: 20px;"> <thead> <tr> <th colspan="3">External Pad Set</th> <th colspan="5">Configuration of MIPI Lane</th> </tr> <tr> <th>IM2</th> <th>IM1</th> <th>IM0</th> <th>D0P/N Pin</th> <th>D1P/N Pin</th> <th>CLKP/N Pin</th> <th>D2P/N Pin</th> <th>D3P/N Pin</th> </tr> </thead> <tbody> <tr> <td>0</td> <td>1</td> <td>0</td> <td>D0P/N</td> <td>D1P/N</td> <td>CLKP/N</td> <td>D2P/N</td> <td>D3P/N</td> </tr> <tr> <td>0</td> <td>1</td> <td>1</td> <td>D0N/P</td> <td>D1N/P</td> <td>CLKN/P</td> <td>D2N/P</td> <td>D3N/P</td> </tr> </tbody> </table>	External Pad Set			Configuration of MIPI Lane					IM2	IM1	IM0	D0P/N Pin	D1P/N Pin	CLKP/N Pin	D2P/N Pin	D3P/N Pin	0	1	0	D0P/N	D1P/N	CLKP/N	D2P/N	D3P/N	0	1	1	D0N/P	D1N/P	CLKN/P	D2N/P	D3N/P	
External Pad Set			Configuration of MIPI Lane																																
IM2	IM1	IM0	D0P/N Pin	D1P/N Pin	CLKP/N Pin	D2P/N Pin	D3P/N Pin																												
0	1	0	D0P/N	D1P/N	CLKP/N	D2P/N	D3P/N																												
0	1	1	D0N/P	D1N/P	CLKN/P	D2N/P	D3N/P																												
22	GND	Ground																																	
23	XRES	The external reset input.																																	
24	LEDPWM	LCD frontlight control PWM output pin. Leave the pin open when not in use.																																	
25	VCI	Power supply for analog circuit																																	
26	IOVCC	Power supply for I/O circuit																																	
27	NC	No connection																																	
28	GND	Ground																																	
29	LEDA	Frontlight Anode.																																	
30	LEDK	Frontlight Cathode.																																	

9. AC Characteristics

9.1. DSI Timing Characteristics

(1)

High Speed Mode – Clock Channel Timing

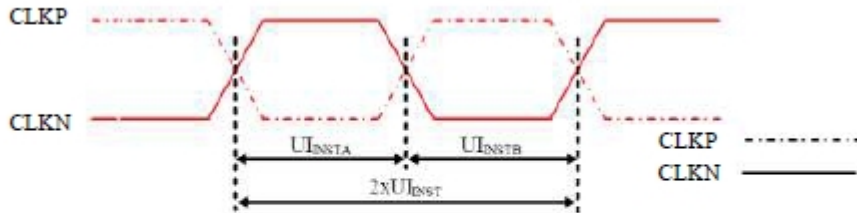

Figure 105: DSI Clock Channel Timing

Table 38: DSI Clock Channel Timing

Signal	Symbol	Parameter	Min	Max	Unit
CLKP/N	$2xUI_{INST}$	Double UI instantaneous	Note 2	25	ns
CLKP/N	UI_{INSTA}, UI_{INSTB} (Note 1)	UI instantaneous Half	Note 2	12.5	ns

Notes:

1. $UI = UI_{INSTA} = UI_{INSTB}$
2. Define the minimum value, see Table 39.

Table 39: Limited Clock Channel Speed

Data type	Two Lanes speed	Three Lanes speed	Four Lanes speed
Data Type = 00 1110 (0Eh), RGB 565, 18 UI per Pixel	566 Mbps	466 Mbps	366 Mbps
Data Type = 01 1110 (1Eh), RGB 666, 18 UI per Pixel	637 Mbps	525 Mbps	412 Mbps
Data Type = 10 1110 (2Eh), RGB 666 Loosely, 24 UI per Pixel	850 Mbps	750 Mbps	650 Mbps
Data Type = 11 1110 (3Eh), RGB 888, 24 UI per Pixel	850 Mbps	750 Mbps	650 Mbps

(2)

High Speed Mode – Data Clock Channel Timing

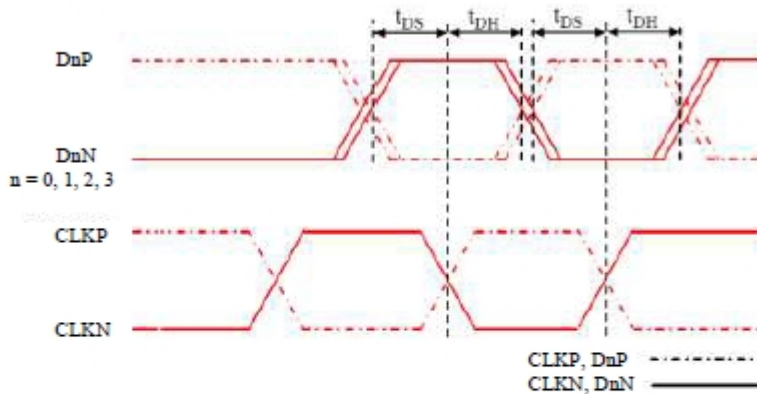

Figure 106: DSI Data to Clock Channel Timings

Table 40: DSI Data to Clock Channel Timings

Signal	Symbol	Parameter	Min	Max
DnP/N, n=0 and 1	t_{DS}	Data to Clock Setup time	0.15xUI	-
	t_{DH}	Clock to Data Hold Time	0.15xUI	-

(3)

High Speed Mode – Rising and Falling Timings

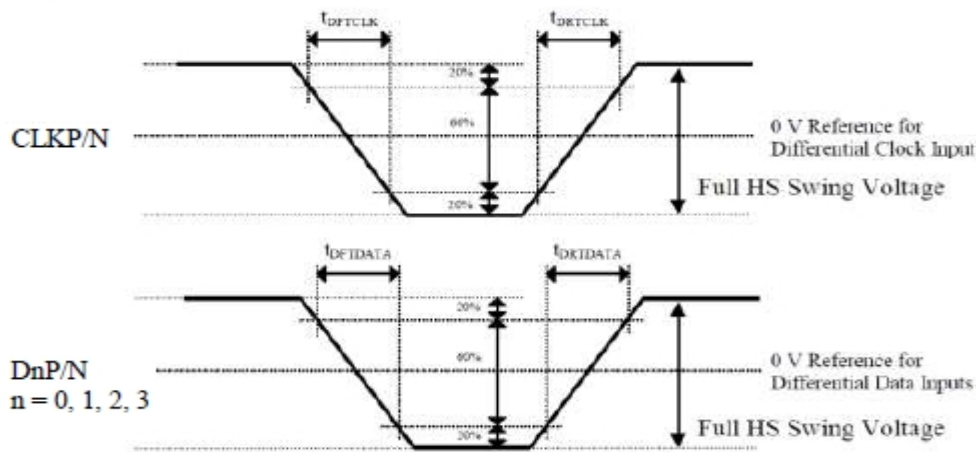

Figure 107: Rising and Falling Timings on Clock and Data Channels

Table 41: Rise and Fall Timings on Clock and Data Channels

Parameter	Symbol	Condition	Specification		
			Min	Typ	Max
Differential Rise Time for Clock	t_{DRCLK}	CLKP/N	150 ps	-	0.3UI (Note)
Differential Rise Time for Data	t_{DRDATA}	DnP/N n=0 and 1	150 ps	-	0.3UI (Note)
Differential Fall Time for Clock	t_{DFCLK}	CLKP/N	150 ps	-	0.3UI (Note)
Differential Fall Time for Data	t_{DFDATA}	DnP/N n=0 and 1	150 ps	-	0.3UI (Note)

(4)

Data Lanes from Low Power Mode to High Speed Mode

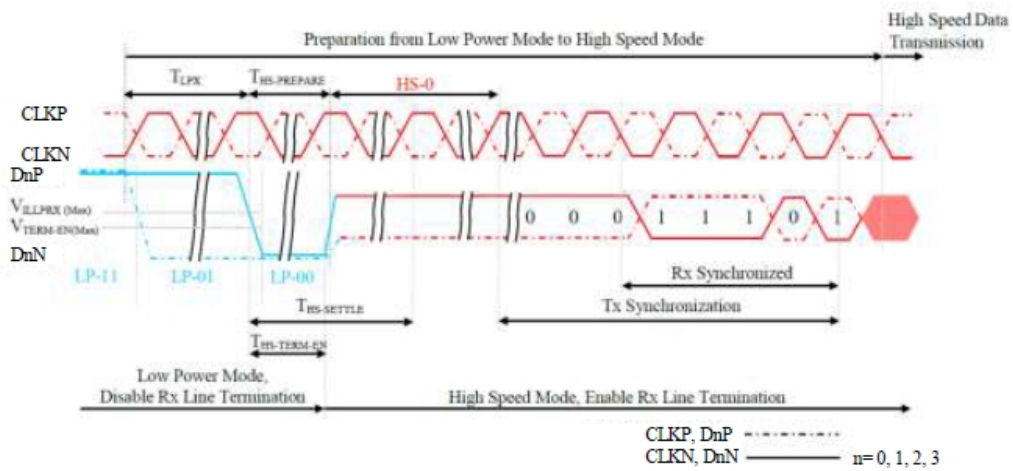

Figure 110: Data Lanes - Low Power Mode to High Speed Mode Timings

Table 44: Data Lanes - Low Power Mode to High Speed Mode Timings

Signal	Symbol	Description	Min	Max	Unit
DnP/N, n = 0 and 1	T_{LPX}	Length of any Low Power State Period	50	-	ns
DnP/N, n = 0 and 1	$T_{HS-PREPARE}$	Time to drive LP-00 to prepare for HS Transmission	$40+4xUI$	$85+6xUI$	ns
DnP/N, n = 0 and 1	$T_{HS-TERM-EN}$	Time to enable Data Lane Receiver line termination measured from when Dn crosses VILMAX	-	$35+4xUI$	ns

(5)

Data Lanes from High Speed Mode to Low Power Mode

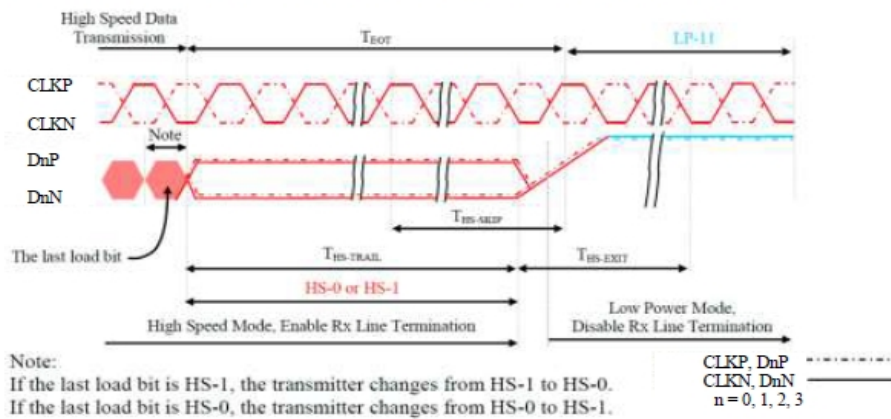

Figure 111: Data Lanes - High Speed Mode to Low Power Mode Timings

Table 45: Data Lanes - High Speed Mode to Low Power Mode Timings

Signal	Symbol	Description	Min	Max	Unit
DnP/N, n = 0 and 1	T _{HS-SKIP}	Time-Out at Display Module (LI9881C-04) to ignore transition period of EoT	40	55+4xUI	ns
DnP/N, n = 0 and 1	T _{HS-EXIT}	Time to driver LP-11 after HS burst	100	-	ns

(6)

DSI Clock Burst – High Speed Mode to/from Low Power Mode

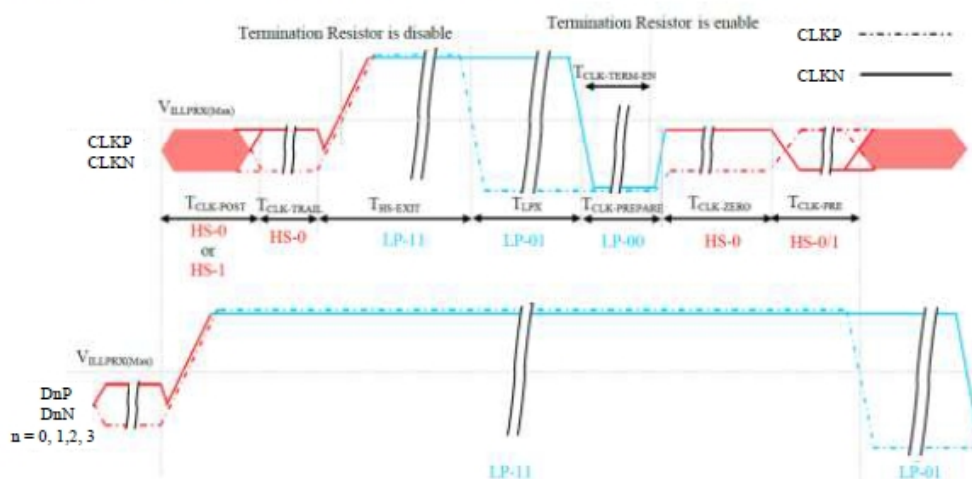
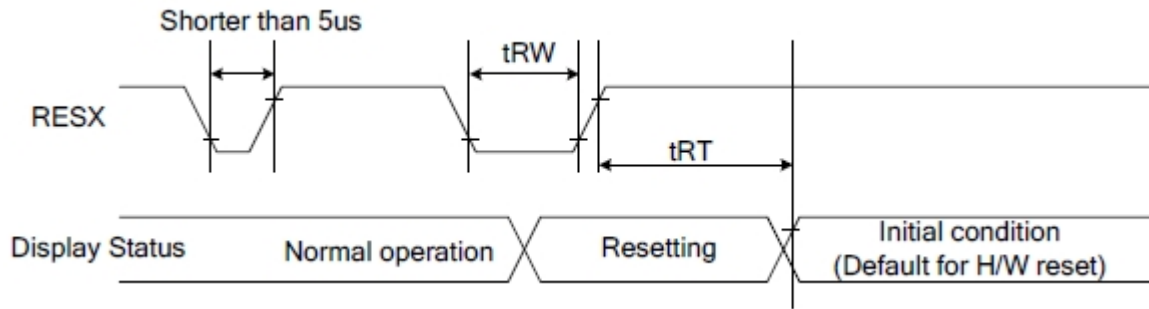

Figure 112: Clock Lanes - High Speed Mode to/from Low Power Mode Timings

Table 46: Clock Lanes - High Speed Mode to/from Low Power Mode Timings

Signal	Symbol	Description	Min	Max	Unit
CLKP/N	T _{CLK-POST}	Time that the MCU shall continue sending HS clock after the last associated Data Lanes has transitioned to LP mode	60+52xUI	-	ns
CLKP/N	T _{CLK-TRAIL}	Time to drive HS differential state after last payload clock bit of a HS transmission burst	60	-	ns
CLKP/N	T _{HS-EXIT}	Time to drive LP-11 after HS burst	100	-	ns
CLKP/N	T _{CLK-PREPARE}	Time to drive LP-00 to prepare for HS transmission	38	95	ns
CLKP/N	T _{CLK-TERMEN}	Time-out at Clock Lane to enable HS termination	-	38	ns
CLKP/N	T _{CLK-PREPARE} + T _{CLK-ZERO}	Minimum lead HS-0 drive period before starting Clock	300	-	ns
CLKP/N	T _{CLK-PRE}	Time that the HS clock shall be driven prior to any associated Data Lane beginning the transition from LP to HS mode	8xUI	-	ns

9.2. Reset Timing



Signal	Symbol	Parameter	Min	Max	Unit
RESX	tRW	Reset pulse duration	10		uS
	tRT	Reset cancel		5 (note 1,5) 120 (note 1,6,7)	mS mS

Notes:

1. The reset cancel also includes required time for loading ID bytes, VCOM setting and other settings from EEPROM to registers. This loading is done every time when there is H/W reset cancel time (tRT) within 5 ms after a rising edge of RESX.
2. Spike due to an electrostatic discharge on RESX line does not cause irregular system reset according to the Table 48.

Table 48: Reset Descript

RESX Pulse	Action
Shorter than 5us	Reset Rejected
Longer than 10us	Reset
Between 5us and 10us	Reset starts

3. During the Resetting period, the display will be blanked (The display enters the blanking sequence, which maximum time is 120 ms, when Reset Starts in the Sleep Out mode. The display remains the blank state in the Sleep In mode.) and then return to Default condition for Hardware Reset.
4. Spike Rejection can also be applied during a valid reset pulse, as shown below:

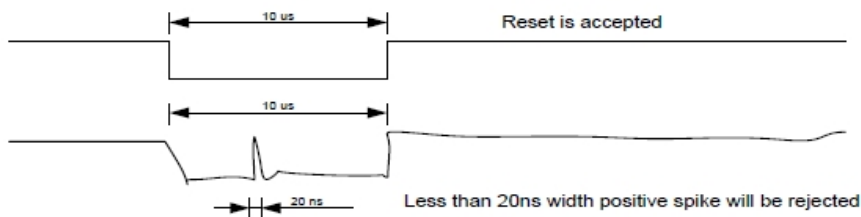

5. When Reset applied during Sleep In Mode.
6. When Reset applied during Sleep Out Mode.
7. It is necessary to wait 5msec after releasing RESX before sending commands. Also Sleep Out command cannot be sent for 120msec.

10. Quality Assurance

10.1.Purpose

This standard for Quality Assurance assures the quality of LCD module products supplied to customer.

10.2.Standard for Quality Test

10.2.1. Sampling Plan:

GB2828.1-2012

Single sampling, general inspection level II

10.2.2. Sampling Criteria:

Visual inspection: AQL 1.5

Electrical functional: AQL 0.65.

10.2.3. Reliability Test:

Detailed requirement refer to Reliability Test Specification.

10.3.Nonconforming Analysis & Disposition

10.3.1. Nonconforming analysis:

10.3.1.1. Customer should provide overall information of non-conforming sample for their complaints.

10.3.1.2. After receipt of detailed information from customer, the analysis of nonconforming parts usually should be finished in one week.

10.3.1.3. If cannot finish the analysis on time, customer will be notified with the progress status.

10.3.2. Disposition of nonconforming:

10.3.2.1. Non-conforming product over PPM level will be replaced.

10.3.2.2. The cause of non-conformance will be analyzed. Corrective action will be discussed and implemented.

10.4.Agreement Items

Shall negotiate with customer if the following situation occurs:

10.4.1. There is any discrepancy in standard of quality assurance.

10.4.2. Additional requirement to be added in product specification.

10.4.3. Any other special problem.

10.5.Standard of the Product Visual Inspection

10.5.1. Appearance inspection:

10.5.1.1. The inspection must be under illumination about 1000 – 1500 lx, and the distance of view must be at 30cm ± 2cm.

10.5.1.2. The viewing angle should be 45° from the vertical line without reflection light or follows customer's viewing angle specifications.

10.5.1.3. Definition of area: A Zone: Active Area, B Zone: Viewing Area,

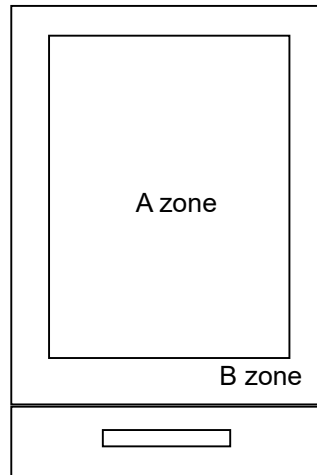
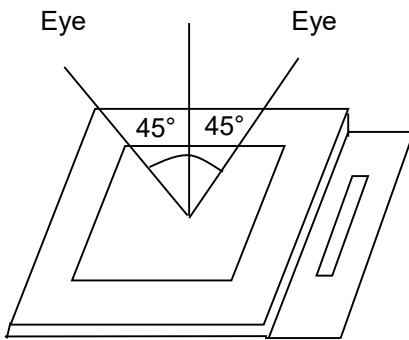

10.5.2. Basic principle:

10.5.2.1. A set of sample to indicate the limit of acceptable quality level must be discussed by both us and customer when there is any dispute happened.

10.5.2.2. New item must be added on time when it is necessary.

10.6. Inspection Specification

No.	Item	Criteria (Unit: mm)																			
01	Black / White spot Foreign material (Round type) Pinholes Stain Particles inside cell. (Minor defect)	<p>$\phi = (a + b) / 2$</p> <p>Distance between 2 defects should more than 3mm apart.</p>	<table border="1"> <thead> <tr> <th>Size</th> <th>Area</th> <th>Acc. Qty</th> </tr> </thead> <tbody> <tr> <td>$\phi \leq 0.20$</td> <td></td> <td>Ignore</td> </tr> <tr> <td>$0.20 < \phi \leq 0.50$</td> <td></td> <td>$N \leq 3$</td> </tr> <tr> <td>$0.50 < \phi$</td> <td></td> <td>0</td> </tr> </tbody> </table>	Size	Area	Acc. Qty	$\phi \leq 0.20$		Ignore	$0.20 < \phi \leq 0.50$		$N \leq 3$	$0.50 < \phi$		0						
			Size	Area	Acc. Qty																
$\phi \leq 0.20$		Ignore																			
$0.20 < \phi \leq 0.50$		$N \leq 3$																			
$0.50 < \phi$		0																			
02	Electrical Defect (Minor defect)	<table border="1"> <thead> <tr> <th></th> <th>Display Area</th> <th>Total</th> <th></th> </tr> </thead> <tbody> <tr> <td>Bright dot</td> <td>$N \leq 2$</td> <td>$N \leq 2$</td> <td rowspan="3">Note1</td> </tr> <tr> <td>Dark dot</td> <td>$N \leq 4$</td> <td>$N \leq 4$</td> </tr> <tr> <td>Total dot</td> <td>$N \leq 4$</td> <td>$N \leq 4$</td> </tr> <tr> <td>Mura</td> <td colspan="2">Not visible through 5% ND filters.</td> <td>Note 2</td> </tr> </tbody> </table> <p>Remark: 1. Bright dot caused by scratch and foreign object accords to item 1.</p>		Display Area	Total		Bright dot	$N \leq 2$	$N \leq 2$	Note1	Dark dot	$N \leq 4$	$N \leq 4$	Total dot	$N \leq 4$	$N \leq 4$	Mura	Not visible through 5% ND filters.		Note 2	
	Display Area	Total																			
Bright dot	$N \leq 2$	$N \leq 2$	Note1																		
Dark dot	$N \leq 4$	$N \leq 4$																			
Total dot	$N \leq 4$	$N \leq 4$																			
Mura	Not visible through 5% ND filters.		Note 2																		

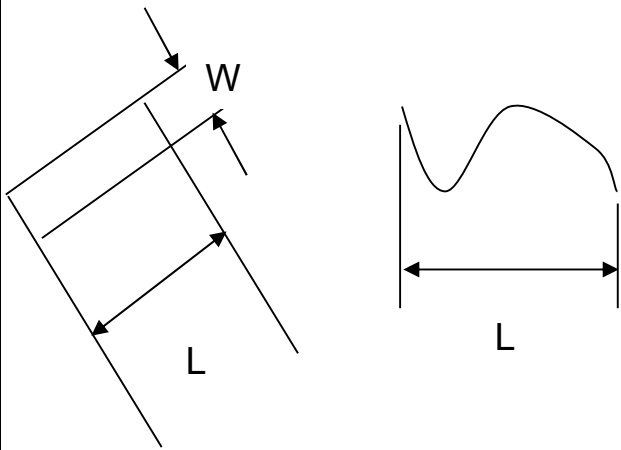
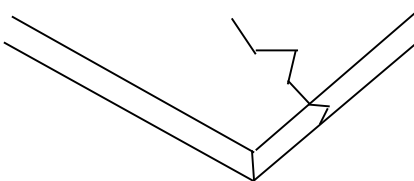
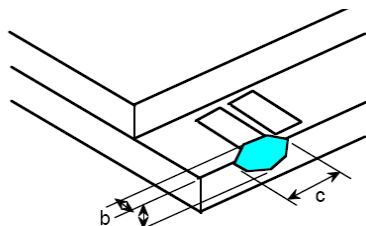
<p>03</p>	<p>Black and White line Scratch Foreign material (Line type) (Minor defect)</p>	 <table border="1" data-bbox="614 716 1236 1030"> <thead> <tr> <th>Length</th> <th>Width</th> <th>Acc. Qty</th> </tr> </thead> <tbody> <tr> <td>/</td> <td>$W \leq 0.03$</td> <td>Ignore</td> </tr> <tr> <td>$L \leq 2.5$</td> <td>$0.03 < W \leq 0.05$</td> <td>3</td> </tr> <tr> <td>$L \leq 2.5$</td> <td>$0.05 < W \leq 0.10$</td> <td>2</td> </tr> <tr> <td>/</td> <td>$0.1 < W$</td> <td>0</td> </tr> <tr> <td colspan="2">Total</td> <td>3</td> </tr> </tbody> </table> <p>Distance between 2 defects should more than 3mm apart. Scratches not viewable through the back of the display are acceptable.</p>	Length	Width	Acc. Qty	/	$W \leq 0.03$	Ignore	$L \leq 2.5$	$0.03 < W \leq 0.05$	3	$L \leq 2.5$	$0.05 < W \leq 0.10$	2	/	$0.1 < W$	0	Total		3
Length	Width	Acc. Qty																		
/	$W \leq 0.03$	Ignore																		
$L \leq 2.5$	$0.03 < W \leq 0.05$	3																		
$L \leq 2.5$	$0.05 < W \leq 0.10$	2																		
/	$0.1 < W$	0																		
Total		3																		
<p>04</p>	<p>Glass Crack (Minor defect)</p>	 <p>Crack is potential to enlarge, any type is not allowed.</p>																		
<p>05</p>	<p>Glass Chipping Pad Area: (Minor defect)</p> 	<table border="1" data-bbox="853 1612 1324 1780"> <thead> <tr> <th>Length and Width</th> <th>Acc. Qty</th> </tr> </thead> <tbody> <tr> <td>$c > 3.0, b < 1.0$</td> <td>1</td> </tr> <tr> <td>$c < 3.0, b < 1.0$</td> <td>3</td> </tr> <tr> <td colspan="2">$a < \text{Glass Thickness}$</td> </tr> </tbody> </table>	Length and Width	Acc. Qty	$c > 3.0, b < 1.0$	1	$c < 3.0, b < 1.0$	3	$a < \text{Glass Thickness}$											
Length and Width	Acc. Qty																			
$c > 3.0, b < 1.0$	1																			
$c < 3.0, b < 1.0$	3																			
$a < \text{Glass Thickness}$																				

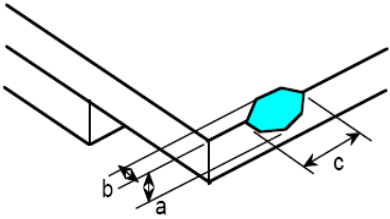
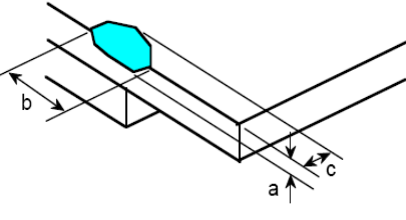
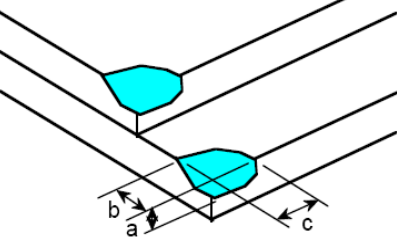
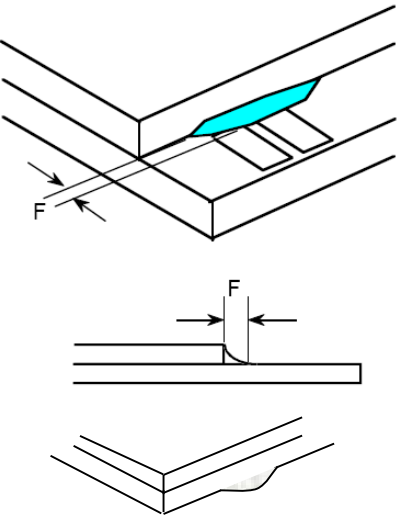
<p>06</p>	<p>Glass Chipping Rear of Pad Area: (Minor defect)</p> 	<table border="1"> <thead> <tr> <th>Length and Width</th> <th>Acc. Qty</th> </tr> </thead> <tbody> <tr> <td>$c > 3.0, b < 1.0$</td> <td>1</td> </tr> <tr> <td>$c < 3.0, b < 1.0$</td> <td>2</td> </tr> <tr> <td>$c < 3.0, b < 0.5$</td> <td>4</td> </tr> <tr> <td colspan="2" style="text-align: center;">$a < \text{Glass Thickness}$</td> </tr> </tbody> </table>	Length and Width	Acc. Qty	$c > 3.0, b < 1.0$	1	$c < 3.0, b < 1.0$	2	$c < 3.0, b < 0.5$	4	$a < \text{Glass Thickness}$	
Length and Width	Acc. Qty											
$c > 3.0, b < 1.0$	1											
$c < 3.0, b < 1.0$	2											
$c < 3.0, b < 0.5$	4											
$a < \text{Glass Thickness}$												
<p>07</p>	<p>Glass Chipping Except Pad Area: (Minor defect)</p> 	<table border="1"> <thead> <tr> <th>Length and Width</th> <th>Acc. Qty</th> </tr> </thead> <tbody> <tr> <td>$c > 3.0, b < 1.0$</td> <td>1</td> </tr> <tr> <td>$c < 3.0, b < 1.0$</td> <td>2</td> </tr> <tr> <td>$c < 3.0, b < 0.5$</td> <td>4</td> </tr> <tr> <td colspan="2" style="text-align: center;">$a < \text{Glass Thickness}$</td> </tr> </tbody> </table>	Length and Width	Acc. Qty	$c > 3.0, b < 1.0$	1	$c < 3.0, b < 1.0$	2	$c < 3.0, b < 0.5$	4	$a < \text{Glass Thickness}$	
Length and Width	Acc. Qty											
$c > 3.0, b < 1.0$	1											
$c < 3.0, b < 1.0$	2											
$c < 3.0, b < 0.5$	4											
$a < \text{Glass Thickness}$												
<p>08</p>	<p>Glass Corner Chipping: (Minor defect)</p> 	<table border="1"> <thead> <tr> <th>Length and Width</th> <th>Acc. Qty</th> </tr> </thead> <tbody> <tr> <td>$c < 3.0, b < 3.0$</td> <td>Ignore</td> </tr> <tr> <td colspan="2" style="text-align: center;">$a < \text{Glass Thickness}$</td> </tr> </tbody> </table>	Length and Width	Acc. Qty	$c < 3.0, b < 3.0$	Ignore	$a < \text{Glass Thickness}$					
Length and Width	Acc. Qty											
$c < 3.0, b < 3.0$	Ignore											
$a < \text{Glass Thickness}$												
<p>09</p>	<p>Glass Burr: (Minor defect)</p> 	<table border="1"> <thead> <tr> <th>Length</th> <th>Acc. Qty</th> </tr> </thead> <tbody> <tr> <td>$F < 1.0$</td> <td>Ignore</td> </tr> </tbody> </table> <p>Glass burr don't affect assemble and module dimension.</p>	Length	Acc. Qty	$F < 1.0$	Ignore						
Length	Acc. Qty											
$F < 1.0$	Ignore											

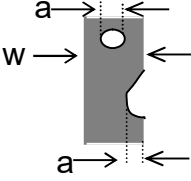
10	<p>FPC Defect: (Minor defect)</p> 	<p>10.1 Dent, pinhole width $a < w/3$. (w: circuitry width.) 10.2 Open circuit is unacceptable. 10.3 No oxidation, contamination and distortion.</p>										
11	Bubble on Polarizer (Minor defect)	<table border="1" data-bbox="727 551 1198 763"> <thead> <tr> <th>Diameter</th> <th>Acc. Qty</th> </tr> </thead> <tbody> <tr> <td>$\varphi \leq 0.20$</td> <td>Ignore</td> </tr> <tr> <td>$0.20 < \varphi \leq 0.30$</td> <td>4</td> </tr> <tr> <td>$0.30 < \varphi \leq 0.50$</td> <td>1</td> </tr> <tr> <td>$0.50 < \varphi$</td> <td>None</td> </tr> </tbody> </table>	Diameter	Acc. Qty	$\varphi \leq 0.20$	Ignore	$0.20 < \varphi \leq 0.30$	4	$0.30 < \varphi \leq 0.50$	1	$0.50 < \varphi$	None
Diameter	Acc. Qty											
$\varphi \leq 0.20$	Ignore											
$0.20 < \varphi \leq 0.30$	4											
$0.30 < \varphi \leq 0.50$	1											
$0.50 < \varphi$	None											
12	Dent on Polarizer (Minor defect)	<table border="1" data-bbox="727 824 1198 1037"> <thead> <tr> <th>Diameter</th> <th>Acc. Qty</th> </tr> </thead> <tbody> <tr> <td>$\varphi \leq 0.20$</td> <td>Ignore</td> </tr> <tr> <td>$0.20 < \varphi \leq 0.30$</td> <td>4</td> </tr> <tr> <td>$0.30 < \varphi \leq 0.50$</td> <td>1</td> </tr> <tr> <td>$0.50 < \varphi$</td> <td>None</td> </tr> </tbody> </table>	Diameter	Acc. Qty	$\varphi \leq 0.20$	Ignore	$0.20 < \varphi \leq 0.30$	4	$0.30 < \varphi \leq 0.50$	1	$0.50 < \varphi$	None
Diameter	Acc. Qty											
$\varphi \leq 0.20$	Ignore											
$0.20 < \varphi \leq 0.30$	4											
$0.30 < \varphi \leq 0.50$	1											
$0.50 < \varphi$	None											
13	Bezel	<p>13.1 No rust, distortion on the Bezel. 13.2 No visible fingerprints, stains or other contamination.</p>										
14	PCB	<p>14.1 No distortion or contamination on PCB terminals. 14.2 All components on PCB must same as documented on the BOM/component layout. 14.3 Follow IPC-A-600F.</p>										
15	Soldering	Follow IPC-A-610C standard										
16	Electrical Defect (Major defect)	<p>The below defects must be rejected. 16.1 Missing vertical / horizontal segment, 16.2 Abnormal Display. 16.3 No function or no display. 16.4 Current exceeds product specifications. 16.5 LCD viewing angle defect. 16.6 No frontlight. 16.7 Dark frontlight. 16.8 Touch Panel no function.</p>										

Remark: LCD Panel Broken shall be rejected. Defect out of LCD viewing area is acceptable.

10.7. Classification of Defects

10.7.1. Visual defects (Except no / wrong label) are treated as minor defect and electrical defect is major.

10.7.2. Two minor defects are equal to one major in lot sampling inspection.

10.8. Identification/marketing criteria

Any unit with illegible / wrong /double or no marking/ label shall be rejected.

10.9. Packing

10.9.1. There should be no damage of the outside carton box, each packaging box should have one identical label.

10.9.2. Modules inside package box should have compliant mark.

10.9.3. All direct package materials shall offer ESD protection.

Note1: Bright dot is defined as the defective area of the dot is larger than 50% of one sub-pixel area.

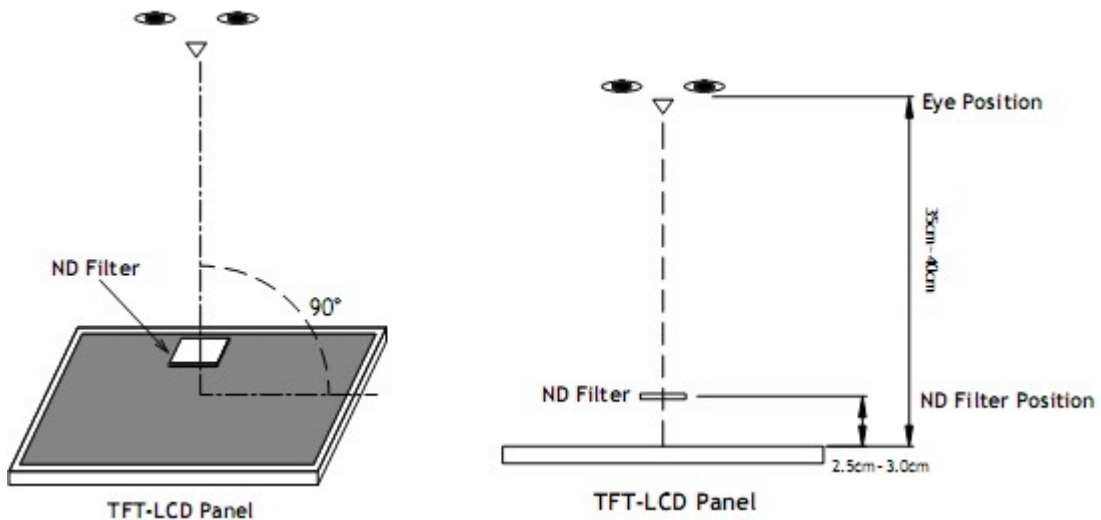

Bright dot: The bright dot size defect at black display pattern. It can be recognized by 2% transparency of filter when the distance between eyes and panel is 350mm±50mm.

Dark dot: Cyan, Magenta or Yellow dot size defect at white display pattern. It can be recognized by 5% transparency of filter when the distance between eyes and panel is 350mm±50mm.

Note2: Mura on display which appears darker / brighter against background brightness on parts of display area.

11. Reliability Specification

No	Item	Condition	Quantity	Criteria
1	High Temperature Operating	+70°C, 96Hrs	2	GB/T2423.2-2008
2	Low Temperature Operating	-20°C, 96Hrs	2	GB/T2423.1-2008
3	High Humidity Storage	+50°C, 90%RH, 96Hrs	2	GB/T2423.3-2016
4	High Temperature Storage	+80°C, 96Hrs	2	GB/T2423.2-2008
5	Low Temperature Storage	-30°C, 96Hrs	2	GB/T2423.1-2008
6	Thermal Cycling Test Storage	-20°C, 60min ~ +70°C, 60min, 20 cycles.	2	GB/T2423.22-2012
7	Packing vibration	Frequency range:10Hz~50Hz Acceleration of gravity:5G X, Y, Z 30 min for each direction.	-	GB/T5170.14-2009
8	Electrical Static Discharge	Air: ±4kV 150pF/330 Ω 5 times Contact: ±2kV 150pF/330 Ω 5 times	2	GB/T17626.2-2018
9	Drop Test (Packaged)	Height: 80 cm,1 corner, 3 edges, 6 surfaces.	-	GB/T2423.8-1995

Note1. No deflection cosmetic and operational function allowable.

Note2. Total current Consumption should be below double of initial value

12. Precautions and Warranty

12.1.Safety

- 12.1.1. The liquid crystal in the LCD is poisonous. Do not put it in your mouth. If the liquid crystal touches your skin or clothes, wash it off immediately using soap and water.
- 12.1.2. Since the liquid crystal cells are made of glass, do not apply strong impact on them. Handle with care.

12.2.Handling

- 12.2.1. Reverse and use within ratings in order to keep performance and prevent damage.
- 12.2.2. Do not wipe the polarizer with dry cloth, as it might cause scratch. If the surface of the LCD needs to be cleaned, wipe it swiftly with cotton or other soft cloth soaked with petroleum IPA, do not use other chemicals.

12.3.Storage

- 12.3.1. Do not store the LCD module beyond the specified temperature ranges.
- 12.3.2. Strong light exposure causes degradation of polarizer and color filter.

12.4.Metal Pin (Apply to Products with Metal Pins)

- 12.4.1. Pins of LCD and frontlight
 - 12.4.1.1. Solder tip can touch and press on the tip of Pin LEAD during the soldering

12.4.1.2. Recommended Soldering Conditions

Solder Type: Sn96.3~94-Ag3.3~4.3-Cu0.4~1.1

Maximum Solder Temperature: 370°C

Maximum Solder Time: 3s at the maximum temperature

Recommended Soldering Temp: 350±20°C

Typical Soldering Time: ≤3s

12.4.1.3. Solder Wetting

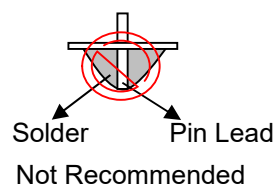
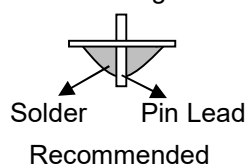

12.4.2. Pins of EL

- 12.4.2.1. Solder tip can touch and press on the tip of EL leads during soldering.
- 12.4.2.2. No Solder Paste on the soldering pad on the motherboard is recommended.

12.4.2.3. Recommended Soldering Conditions

Solder type: Nippon Alimit Leadfree SR-34, size 0.5mm

Recommended Solder Temperature: 270~290°C

Typical Soldering Time: ≤2s

Minimum solder distance from EL lamp (body):2.0mm

- 12.4.2.4. No horizontal press on the EL leads during soldering.
- 12.4.2.5. 180° bend EL leads three times is not allowed.

12.4.2.6. Solder Wetting

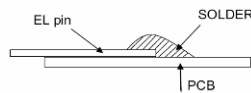

Recommended

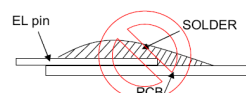

Not Recommended

12.4.2.7. The type of the solder iron:

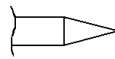

Recommended

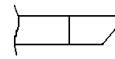

Not Recommended

12.4.2.8. Solder Pad

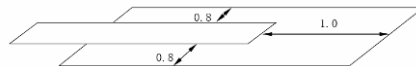

12.5.Operation

- 12.5.1. Do not drive LCD with DC voltage
- 12.5.2. Response time will increase below lower temperature
- 12.5.3. Display may change color with different temperature
- 12.5.4. Mechanical disturbance during operation, such as pressing on the display area, may cause the segments to appear “fractured”.
- 12.5.5. Do not connect or disconnect the LCM to or from the system when power is on.
- 12.5.6. Never use the LCM under abnormal condition of high temperature and high humidity.
- 12.5.7. Module has high frequency circuits. Sufficient suppression to the electromagnetic interface shall be done by system manufacturers. Grounding and shielding methods may be important to minimize the interference.
- 12.5.8. *Do not display the fixed pattern for long time (we suggest the time not longer than one hour) because it will develop image sticking due to the TFT structure.*

12.6.Static Electricity

- 12.6.1. CMOS LSIs are equipped in this unit, so care must be taken to avoid the electro-static charge, by ground human body, etc.
- 12.6.2. The normal static prevention measures should be observed for work clothes and benches.
- 12.6.3. The module should be kept into anti-static bags or other containers resistant to static for storage.

12.7.Limited Warranty

- 12.7.1. Our warranty liability is limited to repair and/or replacement. We will not be responsible for any consequential loss.
- 12.7.2. If possible, we suggest customer to use up all modules in six months. If the module storage time over twelve months, we suggest that recheck it before the module be used.
- 12.7.3. After the product shipped, any product quality issues must be feedback within three months, otherwise, we will not be responsible for the subsequent or consequential events.

13. Outline Drawing

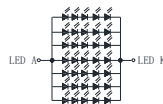
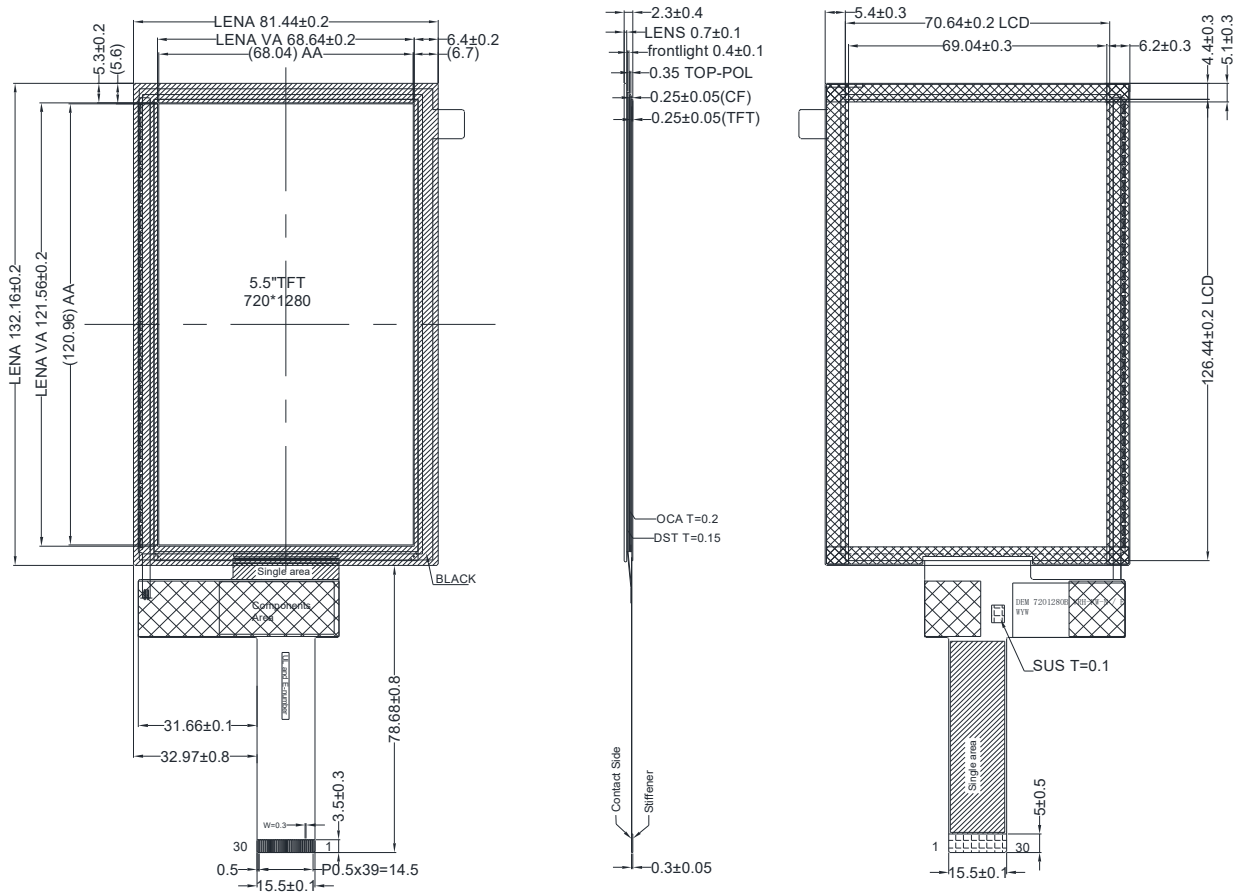

NOTES:

1. Display type: 5.5\"TFT
 2. Viewing direction: FULL viewing
 3. Polarizer mode: Reflective/Normal white/Anti-glare
 4. Operation temperature: -20°C~+70°C
 5. Storage temperature: -30°C~+80°C
 6. Driver IC: ILI9881C
 7. Frontlight : White(35 LED)/16V/140mA
 8. Power supply voltage: 3.3V
 9. ROHS must be complied
- * Unspecification tolerance are ±0.2mm

NO.	PIN NAME
1	MTP_PWR
2	GND
3	D3N
4	D3P
5	GND
6	D2N
7	D2P
8	GND
9	D1N
10	D1P
11	GND
12	D0N
13	D0P
14	GND
15	CLKN
16	CLKP
17	GND
18	NC
19	NC
20	NC
21	IM0
22	GND
23	XRES
24	LEDPWM
25	VCI
26	IOVCC
27	NC
28	GND
29	LEDA
30	LEDK