

DISPLAY Elektronik GmbH

DATA SHEET

LCD MODULE

**DEM 800480H2 VMX-PW-N
(C-TOUCH)**

Product Specification

Version:1

11.01.2023

Revision History

VERSION	DATE	REVISED PAGE NO.	Note
0	05.08.2022		First issue
1	11.01.2023		Modify Contour drawing & Color Chromaticity

Contents

- 1.Summary
- 2.General Specification
- 3.Interface
- 4.Contour Drawing
- 5.Block Diagram
- 6.Absolute Maximum Ratings
- 7.Electrical Characteristics
- 8.AC Characteristics
- 9.Optical Characteristics
- 10.Reliability
- 11.Touch Panel Information
- 12.Other

1.Summary

TFT 4.3” is a color active matrix thin film transistor (TFT) liquid crystal display without polarizer.

This model is composed of amorphous silicon TFT as a switching device. It is a transmissive type display operating in the normally black mode.

This TFT LCD has a 4.3-inch diagonally measured active display area with 800 x 480 dot (800 horizontal by 480 vertical pixel) resolution. Each pixel is divided into Red, Green, Blue dots which are arranged in vertical stripes.

2.General Specification

- Size: 4.3 inch
- Dot Matrix: 800 x RGB x 480 (TFT) dots
- Module dimension: 105.5(W) x 67.2(H) x 5.44(D) mm
- Active area: 95.04 x 53.856 mm
- Pixel pitch: 0.1188 x 0.1122 mm
- LCD type: TFT, Normally Black, Transmissive
- Viewing Angle: 80/80/80/80
- Aspect Ratio: 16:9
- TFT Driver IC: HX8264+HX8664 or equivalent
- TFT Interface: 24-bit RGB
- Backlight Type: LED, Normally White
- CTP FW Version: 0x07.0x00.0x00.0x00.0x01.0x0C.0x11.0x43
- CTP IC: ILI2130 or equivalent
- CTP Interface: I2C
- CTP Resolution: 16384*16384
- With /Without TP: With CTP
- Surface: Glare

*Color tone slight changed by temperature and driving voltage.

3.Interface

3.1. LCM PIN Definition

Pin	Symbol	Function	Remark
1	VLED-	Power for LED backlight cathode	
2	VLED+	Power for LED backlight anode	
3	GND	Power ground	
4	VCC	Power voltage	
5	R0	Red data	
6	R1	Red data	
7	R2	Red data	
8	R3	Red data	
9	R4	Red data	
10	R5	Red data	
11	R6	Red data	
12	R7	Red data	
13	G0	Green data	
14	G1	Green data	
15	G2	Green data	
16	G3	Green data	
17	G4	Green data	
18	G5	Green data	
19	G6	Green data	
20	G7	Green data	
21	B0	Blue data	
22	B1	Blue data	
23	B2	Blue data	
24	B3	Blue data	
25	B4	Blue data	
26	B5	Blue data	
27	B6	Blue data	
28	B7	Blue data	
29	GND	Power ground	
30	CLK	Pixel clock input pin	
31	DISP	DISP sets the display mode.	

		Function Description	
		DISP	
		L	Standby mode
H	Normal display mode		
32	HSYNC	Horizontal Sync Input. Negative polarity	
33	VSYNC	Vertical Sync Input. Negative polarity.	
34	NC	No connection	
35	NC	No connection	
36	GND	Power ground	
37	NC	No connection	
38	NC	No connection	
39	NC	No connection	
40	NC	No connection	

3.2. CTP PIN Definition

Pin	Symbol	Function	Remark
1	VSS	Ground for analog circuit	
2	VDDT	Power Supply : +3.3V	
3	SCL	I2C clock input	
4	NC	No connection	
5	SDA	I2C data input and output	
6	NC	No connection	
7	/RST	External Reset, Low is active	
8	NC	No connection	
9	/INT	External interrupt to the host	
10	VSS	Ground for analog circuit	

4. Contour Drawing

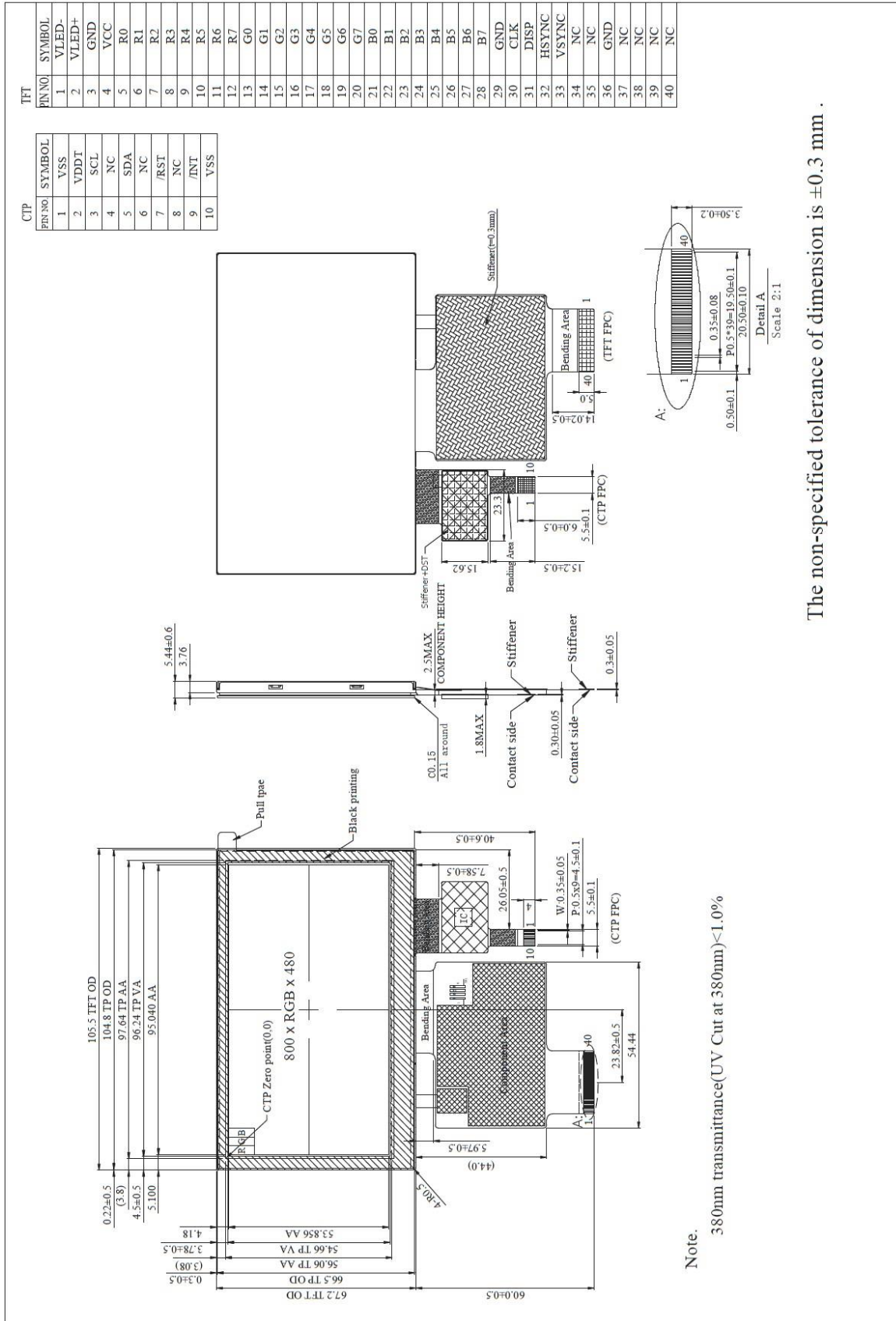

5. Block Diagram

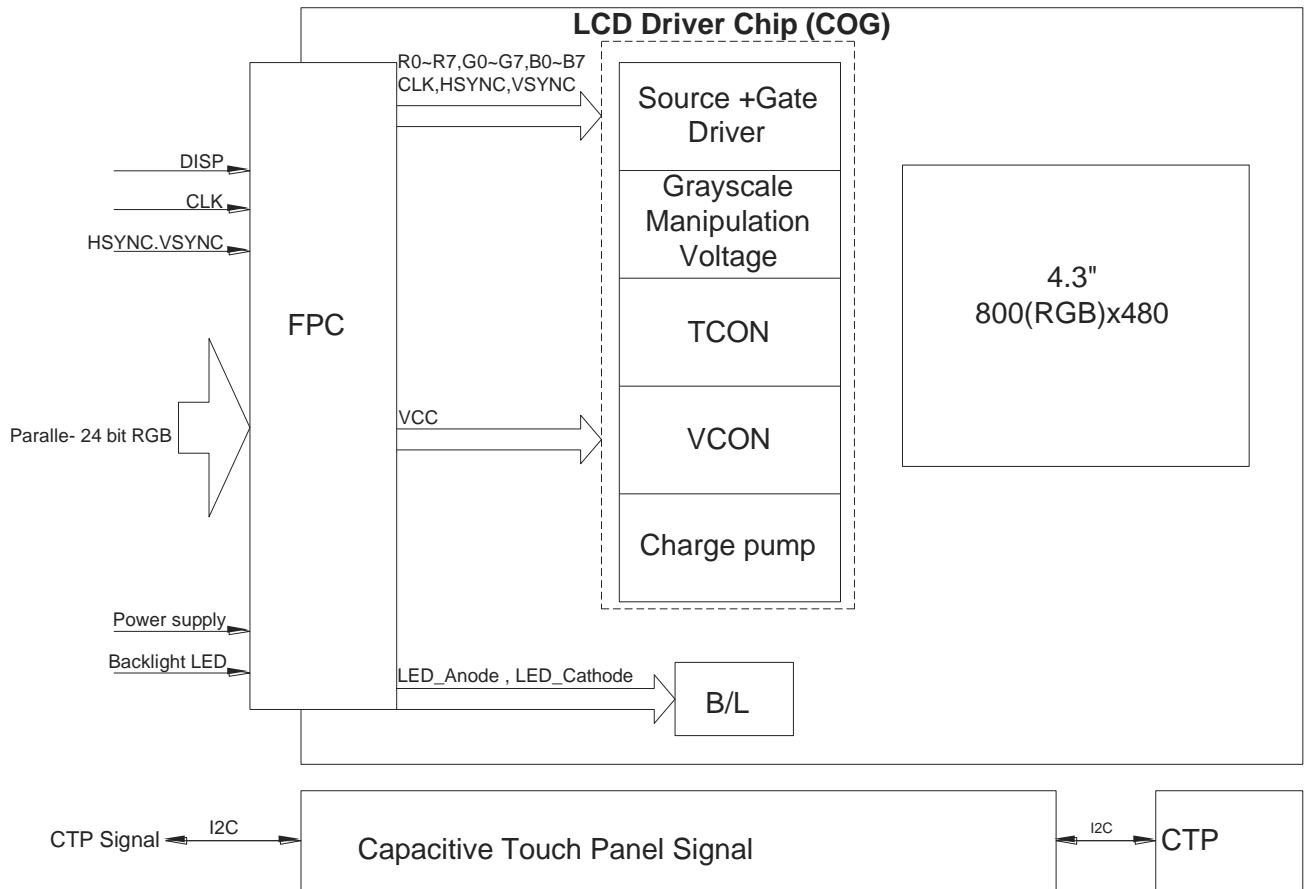

6. Absolute Maximum Ratings

Item	Symbol	Min	Typ	Max	Unit
Operating Temperature	TOP	-30	-	+80	°C
Storage Temperature	TST	-30	-	+80	°C

Note: Device is subject to be damaged permanently if stresses beyond those absolute maximum ratings listed above

1. Temp. $\leq 60^{\circ}\text{C}$, 90% RH MAX. Temp. $> 60^{\circ}\text{C}$, Absolute humidity shall be less than 90% RH at 60°C

7. Electrical Characteristics

7.1. Operating conditions:

Item	Symbol	Min	Typ	Max	Unit	Remark
Supply Voltage For LCM	VCC	3.0	3.3	3.6	V	
Supply Current For LCM	ICC	-	60	90	mA	Note1
Supply CTP	VDDT	3.1	3.3	3.5	V	
	I _{CTP}	-	52	78	mA	

Note 1 : This value is test for VCC=3.3V , Ta=25 °C only

7.2. LED driving conditions

Parameter	Symbol	Min.	Typ.	Max.	Unit	Remark
LED current	-	-	60	-	mA	-
LED voltage	VLED+	21.6	24.0	26.0	V	Note 1
LED Life Time	-	-	50,000	-	Hr	Note 2,3,4

Note 1 : There are 1 Groups LED

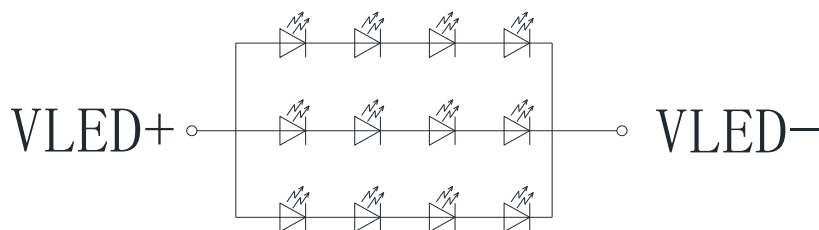

CIRCUIT DIAGRAM

Note 2 : Ta = 25 °C

Note 3 : Brightness to be decreased to 50% of the initial value

Note 4 : The single LED lamp case

8.AC Characteristics

8.1. AC Electrical Characteristics

Signal	Symbol	Min	Typ	Max	Unit
HS setup time	T _{hst}	8	-	-	ns
HS hold time	T _{hhd}	8	-	-	ns
VS setup time	T _{vst}	8	-	-	ns
VS hold time	T _{vhd}	8	-	-	ns
Data setup time	T _{dsu}	8	-	-	ns
Data hole time	T _{dhd}	8	-	-	ns
VCC Power On Slew rate	TPOR	-	-	20	ms
RESET pulse width	TRst	1	-	-	ms
DCLK cycle time	T _{coh}	20	-	-	ns
DCLK pulse duty	T _{cwh}	40	50	60	%

8.2. Input Clock and Data Timing Diagram

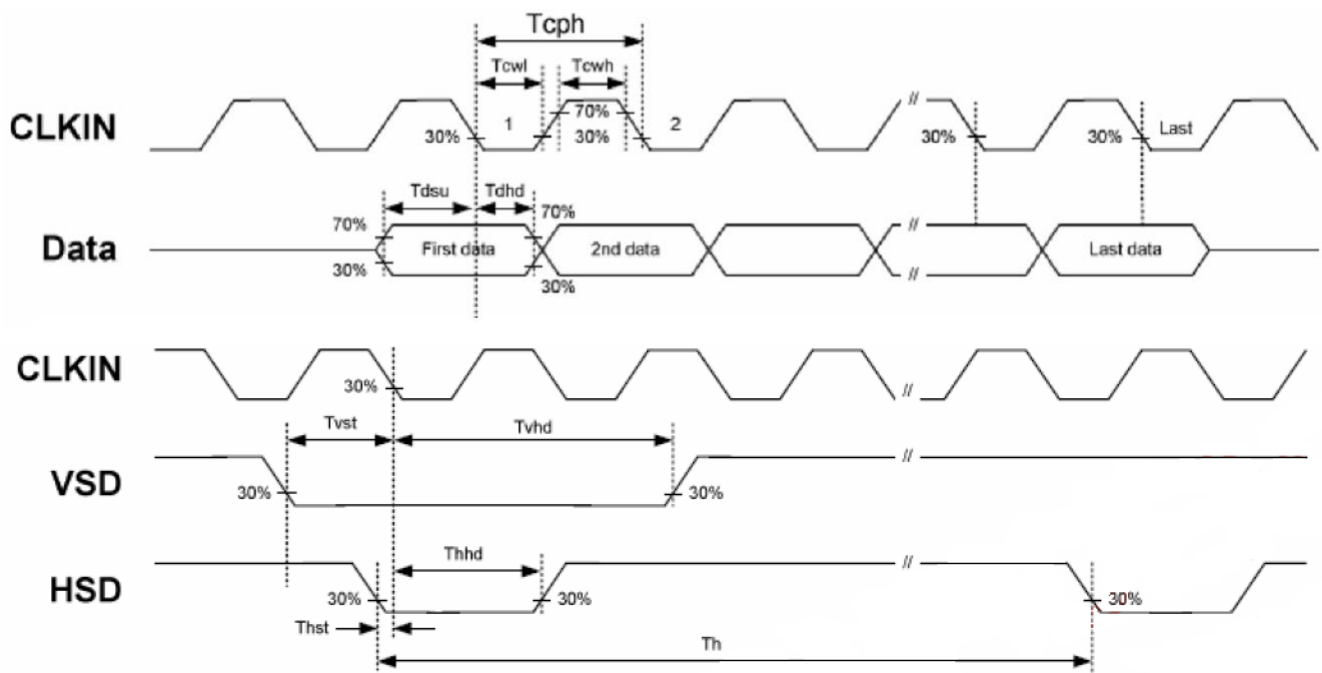

8.3. Timing

Item	Symbol	Values			Unit	Remark
		Min.	Typ.	Max.		
CLK Frequency (DCLK)	fclk		30	50	MHz	
Horizontal Display Area	thd	800			CLK	
One Horizontal Line	th	889	928	1143	CLK	
HS pulse width	thpw	1	48	255	CLK	
HS Blanking	thb	88			CLK	
HS Front Porch	thfp	1	40	255	CLK	
Vertical Display Area	tvd	480			TH	
VS period time	tv	513	525	767	TH	
VS pulse width	tvpw	3	3	255	TH	
VS Blanking	tvb	32			TH	
VS Front Porch	tvfp	1	13	255	TH	

8.4. Data Input Format

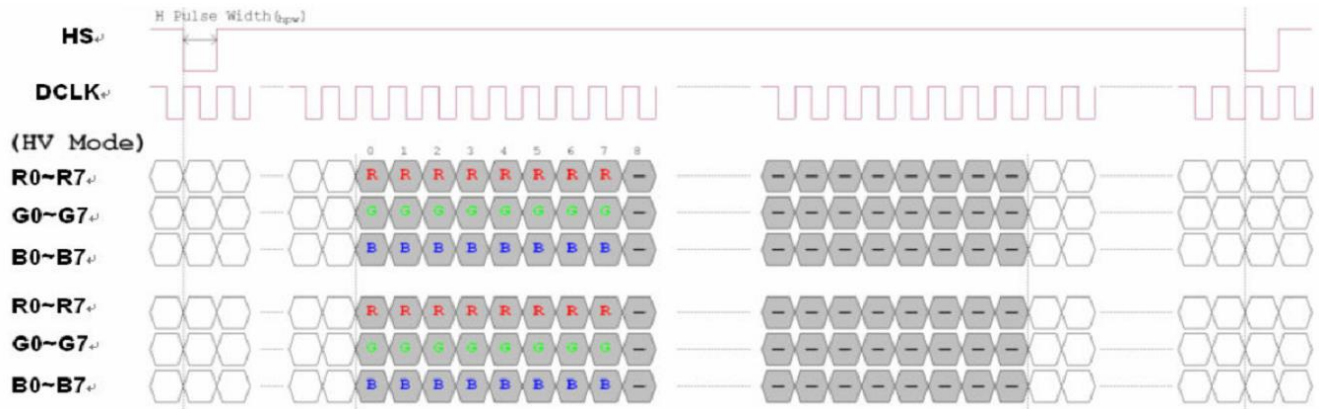

Fig. Horizontal input timing diagram

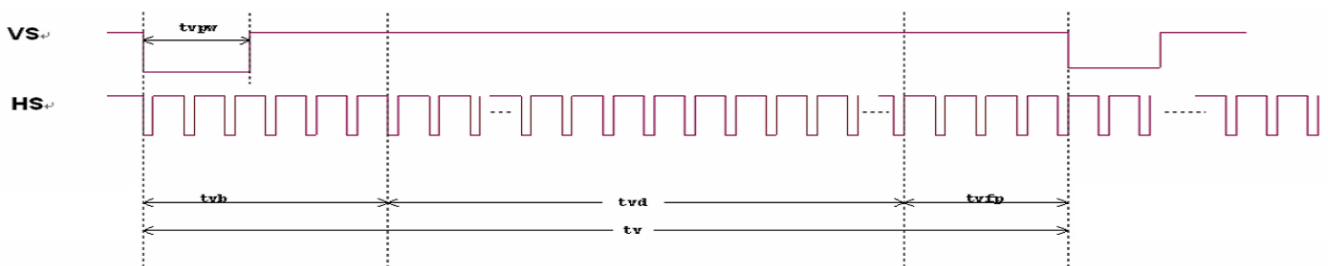

Fig. Vertical input timing diagram

9. Optical Characteristics

Item	Symbol	Condition.	Min	Typ.	Max.	Unit	Remark	
Response time	Tr+ Tf	$\theta=0^\circ$ 、 $\Phi=0^\circ$	-	30	40	ms	Note 3	
Contrast ratio	CR	At optimized viewing angle	640	800	-	-	Note 4	
Color Chromaticity	White	Wx	$\theta=0^\circ$ 、 $\Phi=0$	0.275	0.325	0.375	-	Note 2,6,7
		Wy		0.298	0.348	0.398	-	
Viewing angle	Hor.	Θ_R	CR \geq 10	70	80	-	Deg.	Note 1
		Θ_L		70	80	-		
	Ver.	Φ_T		70	80	-		
		Φ_B		70	80	-		
Brightness	-	-	800	900	-	cd/m ²	Center of display	
Uniformity	(U)	-	75	-	-	%	Note 5	

Ta=25±2°C, IL=60mA

Note 1: Definition of viewing angle range

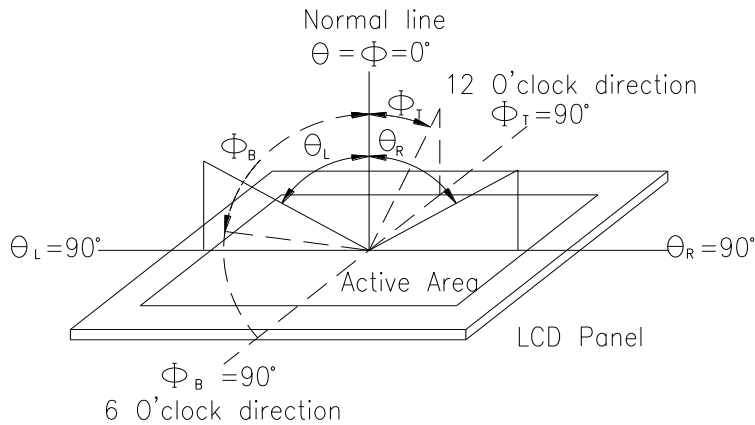

Fig. 10.1. Definition of viewing angle

Note 2: Test equipment setup:

After stabilizing and leaving the panel alone at a driven temperature for 10 minutes, the measurement should be executed. Measurement should be executed in a stable, windless, and dark room. Optical specifications are measured by Topcon BM-7 or BM-5 luminance meter 1.0° field of view at a distance of 50cm and normal direction.

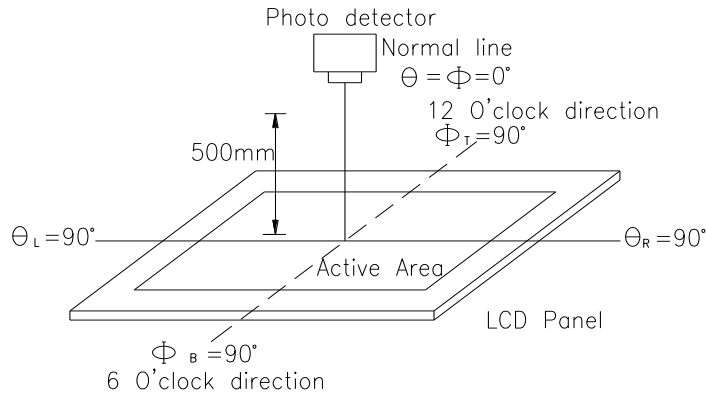
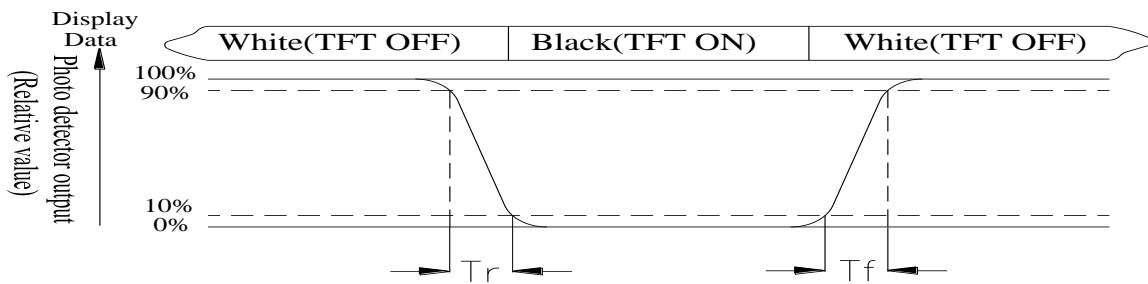

Fig. 10.2. Optical measurement system setup

Note 3: Definition of Response time:

The response time is defined as the LCD optical switching time interval between “White” state and “Black” state. Rise time, T_r , is the time between photo detector output intensity changed from 90% to 10%. And fall time, T_f , is the time between photo detector output intensity changed from 10% to 90%



Note 4: Definition of contrast ratio:

The contrast ratio is defined as the following expression.

$$\text{Contrast ratio (CR)} = \frac{\text{Luminance measured when LCD on the "White" state}}{\text{Luminance measured when LCD on the "Black" state}}$$

Note 5: Definition of Luminance Uniformity

Active area is divided into 9 measuring areas (reference the picture in below). Every measuring point is placed at the center of each measuring area.

Luminance Uniformity (U) = $L_{min}/L_{max} \times 100\%$

L = Active area length

W = Active area width

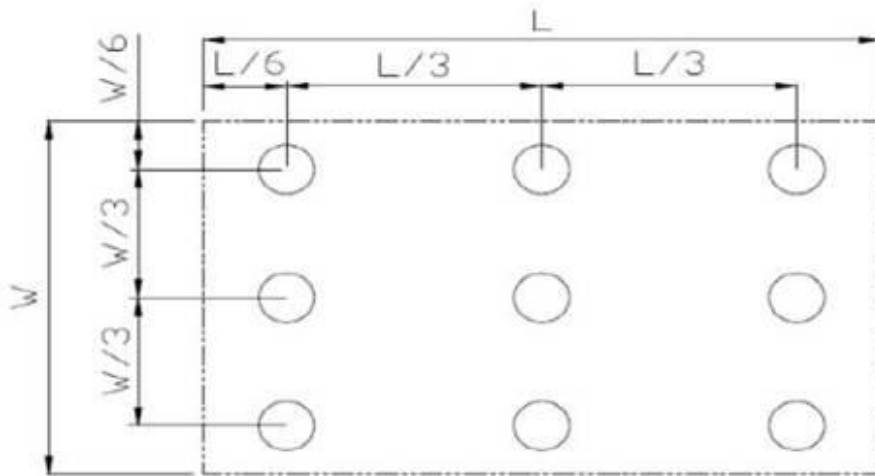

Fig 10.3. Definition of uniformity

Note 6: Definition of color chromaticity (CIE 1931)

Color coordinates measured at the center point of LCD

Note 7: Measured at the center area of the panel when all the input terminals of LCD panel are electrically opened.

10. Reliability

Content of Reliability Test (Super Wide temperature, -30°C ~80°C)

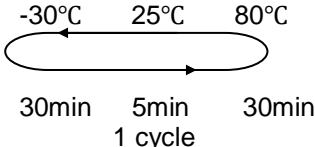
Environmental Test			
Test Item	Content of Test	Test Condition	Note
High Temperature storage	Endurance test applying the high storage temperature for a long time.	80°C 200hrs	2
Low Temperature storage	Endurance test applying the low storage temperature for a long time.	-30°C 200hrs	1,2
High Temperature Operation	Endurance test applying the electric stress (Voltage & Current) and the thermal stress to the element for a long time.	80°C 200hrs	—
Low Temperature Operation	Endurance test applying the electric stress under low temperature for a long time.	-30°C 200hrs	1
High Temperature/ Humidity storage	The module should be allowed to stand at 60°C,90%RH max	60°C,90%RH 96hrs	1,2
Thermal shock resistance	The sample should be allowed stand the following 10 cycles of operation 	-30°C/80°C 10 cycles	—
Vibration test	Endurance test applying the vibration during transportation and using.	Total fixed amplitude : 1.5mm Vibration Frequency : 10~55Hz One cycle 60 seconds to 3 directions of X,Y,Z for Each 15 minutes	3
Static electricity test	Endurance test applying the electric stress to the terminal.	VS=±600V(contact) ,±800v(air), RS=330Ω CS=150pF 10 times	—

Note1: No dew condensation to be observed.

Note2: The function test shall be conducted after 4 hours storage at the normal Temperature and humidity after remove from the test chamber.

Note3: The packing have to including into the vibration testing.

11.Touch Panel Information

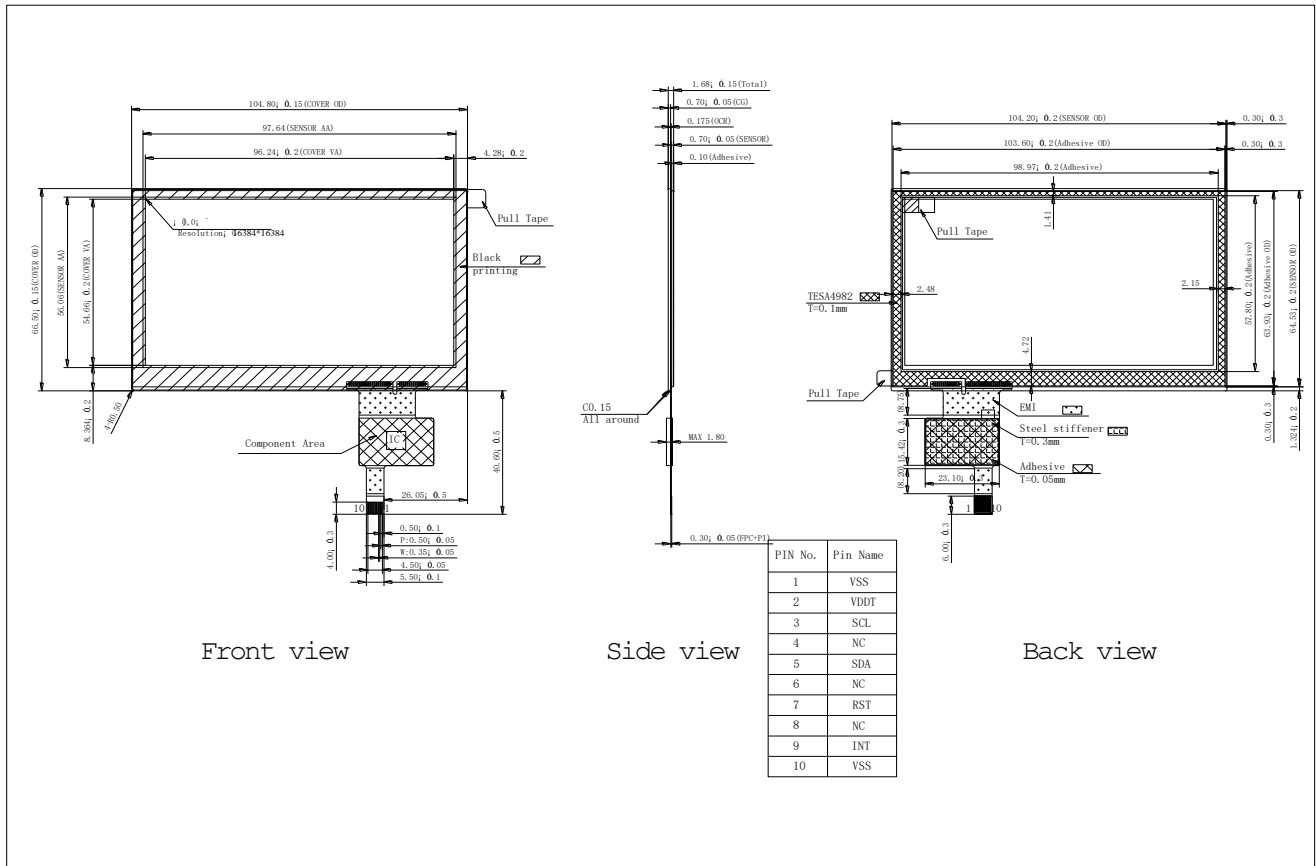

11.1. I2C AC Characteristics

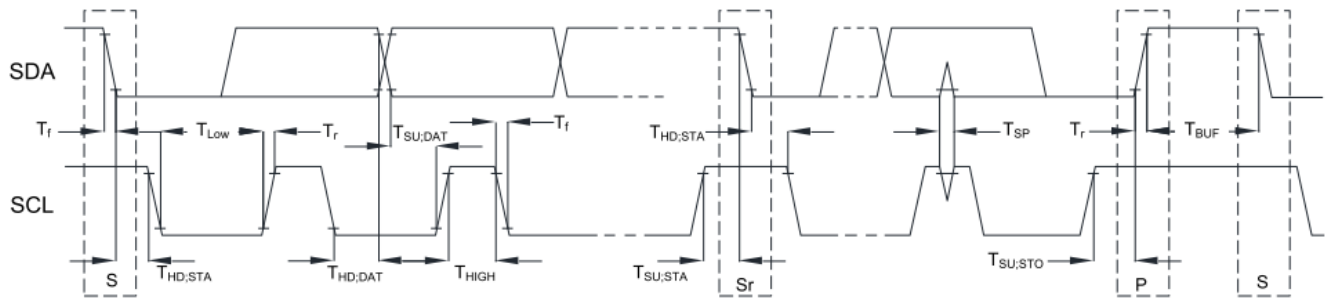

Item	Symbol	100kHz		400kHz		Unit
		Min.	Max.	Min.	Max.	
SCL standard mode clock frequency	F _{SCL}	0	100	0	400	kHz
Hold time (repeated) START condition. After this period, the first clock is generated.	T _{HD,STA}	4	--	0.6	--	us
LOW period of the SCL clock	T _{LOW}	4.7	--	1.3	--	us
HIGH period of the SCL clock	T _{HIGH}	4	--	0.6	--	us
Setup time for a repeat START condition.	T _{SU,STA}	4.7	--	0.6	--	us
Data hold time	T _{HD,DAT}	0	3.45	0	0.9	us
Data setup time	T _{SU,DAT}	250	--	100	--	ns
Rising time of both SDA and SCL signals	T _r	--	1000	--	300	ns
Falling time of both SDA and SCL signals	T _f	--	300	--	300	ns
Setup time for STOP condition.	T _{SU,STO}	4	--	0.6	--	us
Free time between STOP and START condition	T _{BUF}	4.7	--	1.3	--	us
Pulse width of spikes which must be suppressed by input filter	T _{SP}	--	--	0	50	ns

11.2. Power On Sequence

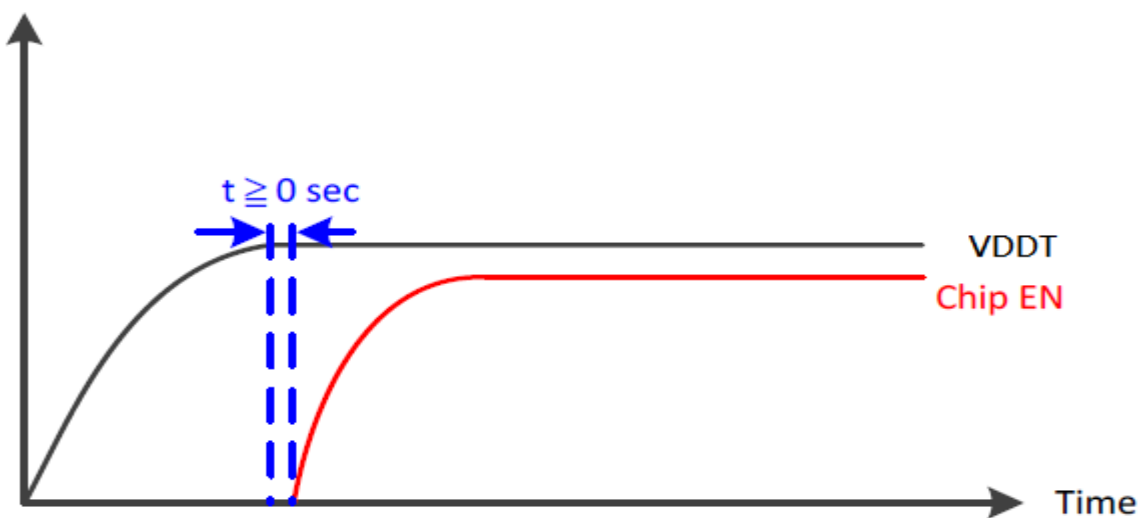

11.3. Power Off to Power On Sequence

