

Display Elektronik GmbH

DATA SHEET

LCD MODULE

**DEM 800600A TMH-PW-N
(C-TOUCH)**

8,0" TFT + PCT

Product Specification

Ver.: 0

03.12.2018

Revise Records

Rev.	Date	Contents	Written	Approved
0	03.12.2018	Preliminary Specification	A	MHI

Special Notes

Note1.	
Note2.	
Note3.	
Note4.	
Note5.	

Contents

1.	General Description and Features	4
1.1	Features	4
1.2	LCD Module	4
2.	Mechanical Information	4
3.	Electrical Specifications	5
3.1	Absolute Max. Ratings	5
3.2	AC Timing Characteristic of The LCD	6
3.3	Back-Light Unit	8
4.	Optical Characteristics	9
4.1	Optical Characteristic of the LCD	9
5.	I/O Terminal	11
5.1	Pin Assignment	11
5.2	Back Light Unit	12
5.3	Block Diagram	12
6.	Displayed Color and Input Data	13
7.	Projected Capacitive Touch Panel	14
7.1	Main Feature	14
7.2	Pin Assignments and Definitions	14
8.	Reliability Condition	15
9.	Dimensional Outlines	16

1. General Description and Features

DEM 800600A TMH-PW-N(C-TOUCH) is a transmissive type color active matrix TFT (Thin Film Transistor) Liquid Crystal Display (LCD) that uses amorphous silicon TFT as a switching device. This model is composed of a TFT-LCD module, a receiver Circuit and a Back-Light unit. Graphics and texts can be displayed on a SVGA 800 (W) x RGB x 600 (H) dots (4:3 aspect ratio) with 262,144 colors. The following table described the features of DEM 800600A TMH-PW-N(C-TOUCH).

1.1 Features

- Transmissive and Back-Light with 27 LEDs are available.
- TN (Twisted Nematic) Mode.
- Digital RGB 18 Bit Interface.
- ROHS Compliance
- Projected Capacitive Touch Panel
- High Brightness

1.2 LCD Module

Item	Specification	Unit
Screen Size	8.0 Inches	Diagonal
Display Resolution	800 x 600	Pixel
Active Area	162.00 x 121.50	mm
Outline Dimension	204.60 x 164.60 x 8.20	mm
Display Mode	Normally White Mode/ Transmissive	--
Pixel Arrangement	R, G, B Vertical Stripe	--
Pixel Size	0.2025 x 0.2025	mm
Surface Treatment	Glass (6H)	
Display Color	262K	--
Viewing Direction	6 o'clock	--
Input Interface	Digital RGB 18bit (6Bits / Each Color) Data Transfer	--

2. Mechanical Information

Item	Min.	Typ.	Max.	Unit	Note
Module Size	Horizontal	--	204.60	--	mm
	Vertical	--	164.60	--	mm
	Thickness	--	8.20	--	mm
Weight	--	(250)	--	g	--

Note (1) Not Include Component. Refer to the Outline Dimension Drawing as attached.

3. Electrical Specifications

3.1 Absolute Max. Ratings

3.1.1 Absolute Ratings of Environment

If the operating condition exceeds the following absolute maximum ratings, the TFT LCD module may be damaged permanently.

($T_a=25\pm 2^\circ\text{C}$, $V_{SS}=\text{GND}=0$)

Item	Symbol	Min.	Max.	Unit	Note
Storage Temperature	T_{STG}	-30	80	$^\circ\text{C}$	(1)
Operating Temperature	T_{OPR}	-20	70	$^\circ\text{C}$	(1,2,3)

Note (1) 95 % RH Max. ($40^\circ\text{C} \geq T_a$). Maximum wet-bulb temperature at 39°C or less. ($T_a > 40^\circ\text{C}$) No condensation.

Note (2) In case of below 0° , the response time of liquid crystal (LC) becomes slower and the color of panel becomes darker than normal one. Level of retardation depends on temperature, because of LC's character

Note (3) Only operation is guaranteed at operating temperature. Contrast, response time, another display quality are evaluated at $+25^\circ\text{C}$.

3.1.2 Electrical Absolute Maximum Ratings

3.1.2.1 TFT-LCD Module

($V_{SS}=\text{GND}=0$)

Parameter	Symbol	Min.	Max.	Unit	Remark
Power Supply Voltage	V_{CC}	-0.3	4.0	V	-
Input Voltage	V_I	-0.3	$V_{CC}+0.3$	V	-

3.1.2.2 Backlight Unit

($V_{SS}=\text{GND}=0$)

Parameter	Symbol	Min.	Max.	Unit	Remark
Current of Backlight Unit	IB	--	225	mA	-
Voltage of Backlight Unit	VB	--	10.5	V	-

3.1.3 DC Electrical Characteristics of the TFT LCD

(Ta=25±2°C, V_{SS}=GND=0)

Item	Symbol	Min.	Typ.	Max.	Unit	Remark	
Power Supply	VCC	3.0	3.3	3.6	V	-	
Input Voltage for Logic	Differential Input High Threshold	VTH	-	-	+100	mV	-
	Differential Input Low Threshold	VTL	-100	-	-	mV	-
Power Supply Current	ICC	-	(220)	(250)	mA	Note 1	

Note1: fv =60 Hz , Ta=25°C , Display Pattern : Black Pattern

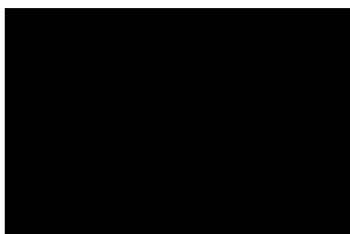

3.2 AC Timing Characteristic of The LCD

3.2.1 Timing Condition

Signal	Parameter	Symbol	Min.	Typ.	Max.	Unit.	Remark
DCLK	CLK Frequency	F _{clk}	-	40	50	MHz	
	CLK Period	T _{cph}	20	-	-	ns	
	CLK Pulse Duty	T _{cwh}	40	50	60	%	
HSYNC	Horizontal Line	T _h	862	1056	1200	CLK	
	HS Display Area	T _{hd}	-	800	-	CLK	
	HS Pulse Width	T _{hpw}	1	-	40	CLK	
	HS Back Porch	T _{hb}	-	46	-	CLK	
	HS Front Porch	T _{hfp}	16	210	354	CLK	
VSYNC	VS Display Area	T _{vd}	-	600	-	th	
	VS Period Time	T _v	624	635	700	th	
	VS Pulse Width	T _{vpw}	1	-	20	th	
	VS Back Porch	T _{vb}	-	23	-	th	
	VS Front Porch	T _{vfp}	1	12	77	th	

3.2.2 Timing Characteristic

3.2.2.1 Horizontal and Vertical input Timing

Horizontal input timing

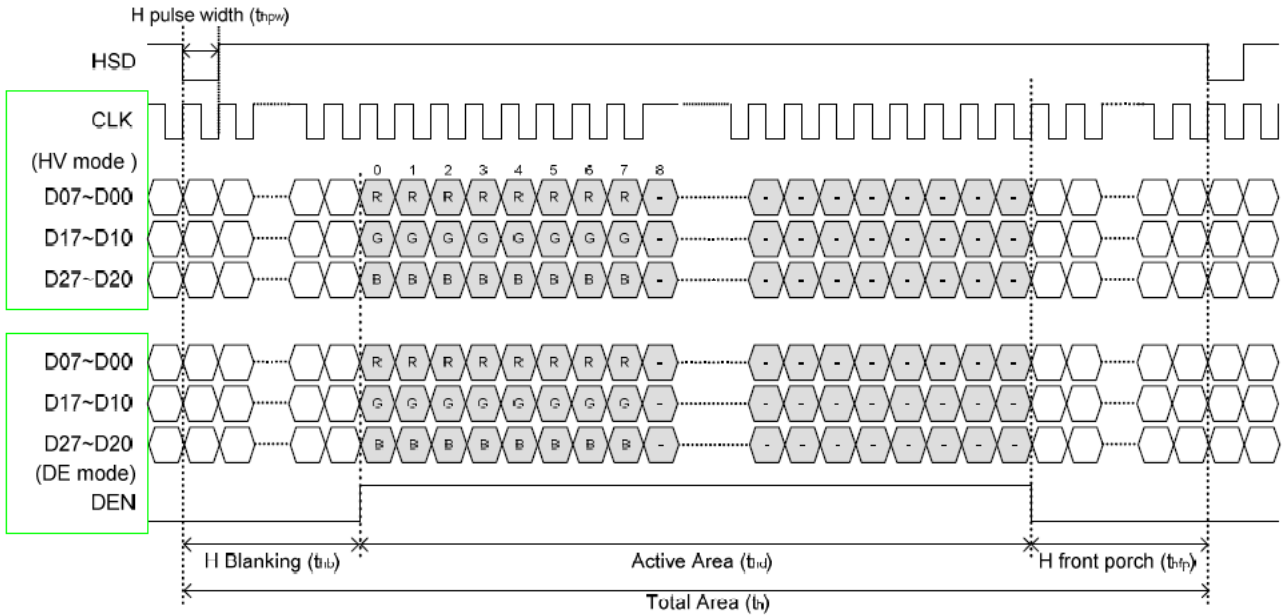

Vertical input timing

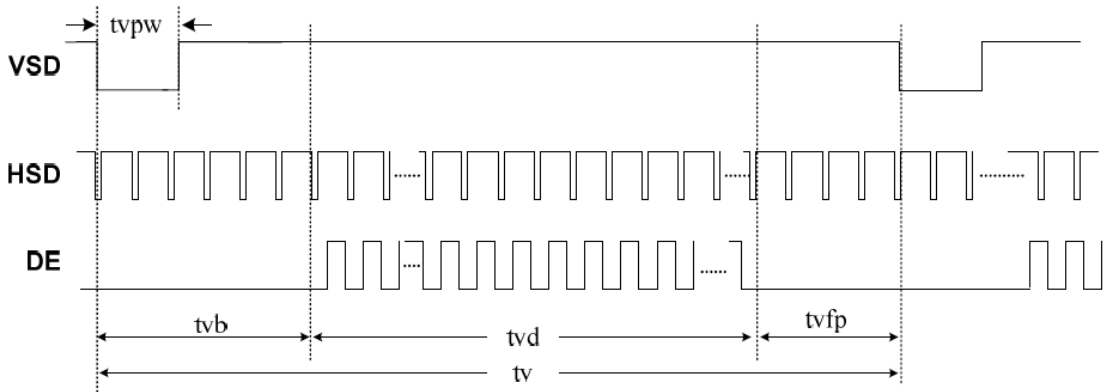

3.2.2.2 Clock and Data Input Waveforms

Signal	Parameter	Symbol	Min.	Typ.	Max.	Unit.	Remark
HSYNC	HS Setup Time	T _{hst}	8	-	-	ns	
	HS Hold Time	T _{hhd}	8	-	-	ns	
VSYNC	VS Setup Time	T _{vst}	8	-	-	ns	
	VS Hold Time	T _{vhd}	8	-	-	ns	
Data	Data Setup Time	T _{dsu}	8	-	-	ns	
	Data Hold Time	T _{dhd}	8	-	-	ns	
DE	DEN Setup Time	T _{vpw}	8	-	-	ns	
	DEN Hold Time	T _{vb}	8	-	-	ns	

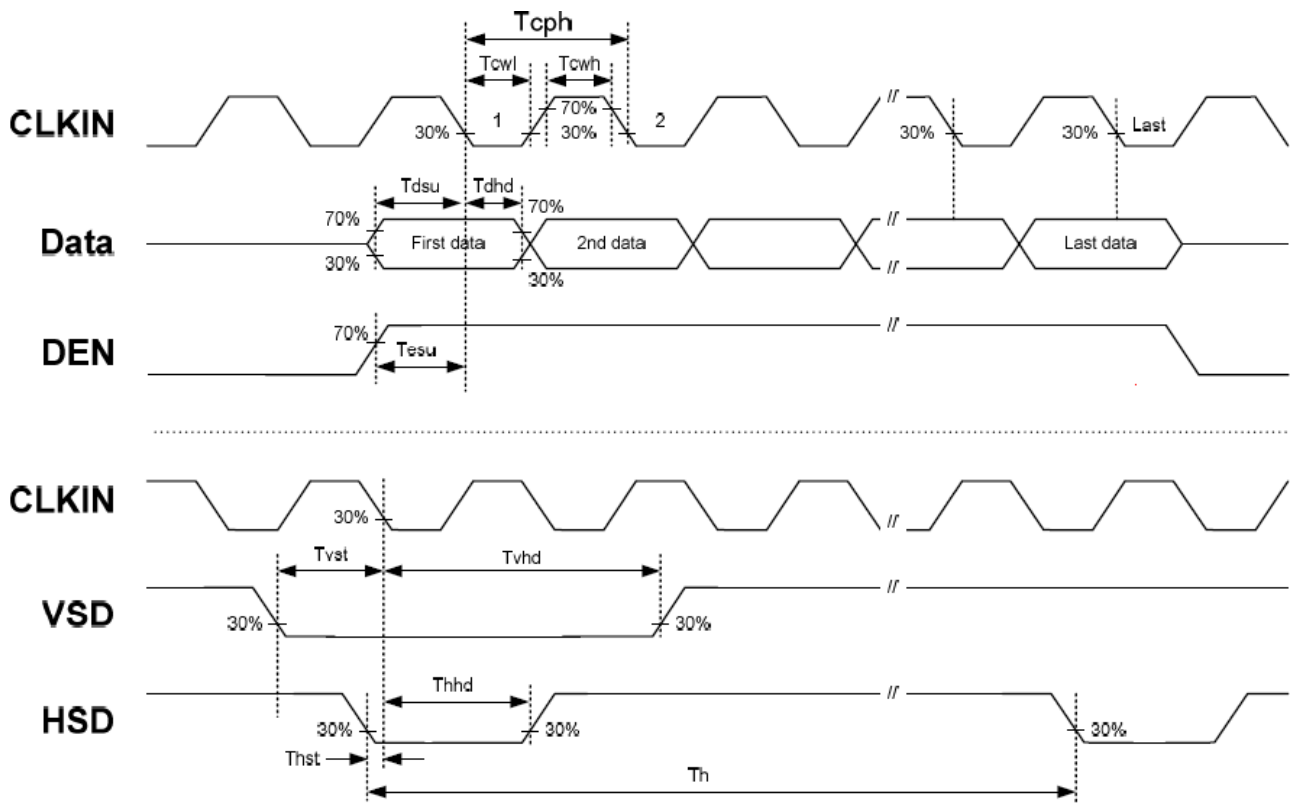

3.3 Back-Light Unit

The Back-light system is an edge-lighting type with 27 white LED (Light Emitting Diode)s. The characteristics of 27 white LEDs are shown in the following tables.

(Ta= Room Temp)

Characteristics	Symbol	Min.	Typ.	Max.	Unit	Note
Forward Voltage	VB	(9.0)	(9.9)	(10.5)	V	-
Forward Current	IB	-	180	-	mA	(1)
Power Consumption	P _{BL}	-	1.782	-	W	(2)
LED Life Time	-	(40000)	-	-	hr	(3)

Note (1) LEDs in 3 series x 9 parallel type.

(2) Where $I_B = 180\text{mA}$, $V_B = 9.9$, $P_{BL} = V_B \times I_B$

(3) The environmental conducted under ambient air flow, at $T_a = 25 \pm 2^\circ\text{C}$, $60\%RH \pm 5\%$

4. Optical Characteristics

4.1 Optical Characteristic of the LCD

The following items are measured under stable conditions. The optical characteristics should be measured in a dark room or equivalent state with the methods.

Measuring equipment: BM-7A

Item	Symbol	Condition	Min	Type	Max	Unit	Note	
Brightness	B	-	(250)	(320)	-	cd/m ²	-	
Response Time	T _r	θ=0°	-	10	-	ms	-	
	T _f		-	15	-	ms		
Contrast Ratio	CR	At optimized viewing angle	(400)	(500)	-	-	-	
Luminance Uniformity	ΔL		70	75		%	-	
Color Chromaticity (CIE 1931)	White	W _x	(0.260)	(0.310)	(0.360)	-	BM-7A	
		W _y	(0.280)	(0.330)	(0.380)			
Viewing Angle (6H)	Hor.	θ _R	CR≥10	60	70	-	Degree	-
		θ _L		60	70	-		
	Ver.	θ _U		40	50	-		
		θ _D		60	75	-		

a. Test equipment setup

After stabilizing and leaving the panel alone shall be warmed up for the stable operation of LCM, the measurement should be executed. Measurement should be executed in a stable, windless, and dark room. Optical specifications are measured by Topcon BM-7(fast) with a viewing angle of 2° at a distance of 50cm and normal direction.

b. Definition of response time: Tr and Tf

The response time is defined as the following figure and shall be measured by switching the input signal for "black" and "white".

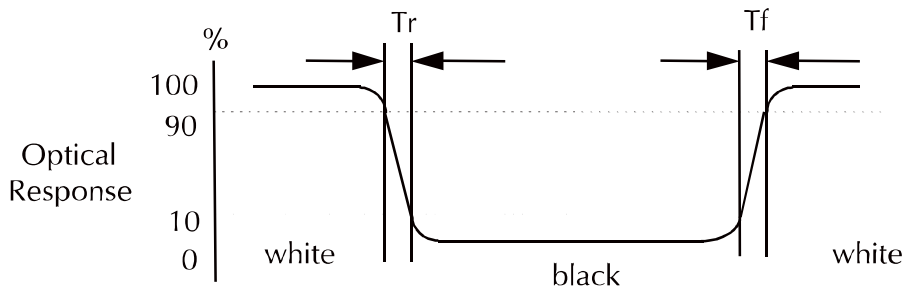

c. Definition of contrast ratio:

$$\text{Contrast Ratio (CR)} = \frac{\text{Brightness measured when LCD is at "white state"}}{\text{Brightness measured when LCD is at "black state"}}$$

d. Measured at the center area of the panel when all the input terminals of LCD panel are electrically opened.

e. View Angle

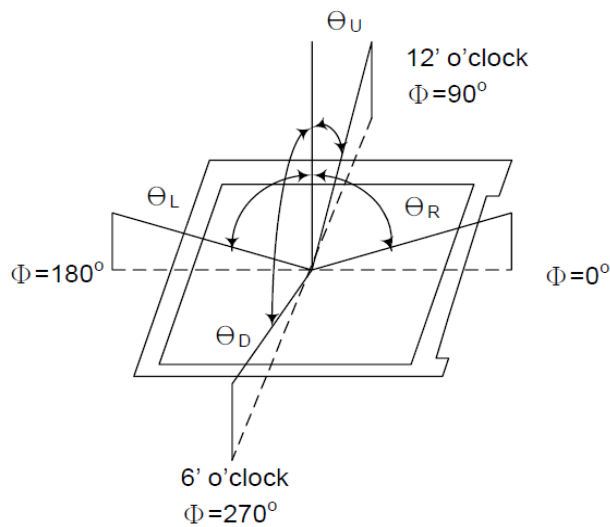

f. Definition of Luminance of White: Luminance of white at the center points

Light Source of Back-Light Unit	LED Type
---------------------------------	----------

g. Definition of White Uniformity

$$\text{White Uniformity} = \frac{\text{Min. luminance of white among 9-points}}{\text{Max. luminance of white among 9-points}} \times 100\%$$

5. I/O Terminal

5.1 Pin Assignment (Connector Part No: 5F2.2535E-A3821.140 or equivalent.)

Pin No.	Symbol	I/O	Function	Remark
1	GND	P	Ground	
2	GND	P	Ground	
3	NC	-	No Connect	
4	NC	-	No Connect	
5	NC	-	No Connect	
6	NC	-	No Connect	
7	VCC	P	Power Supply Logic voltage	
8	VCC	P	Power Supply Logic voltage	
9	DE	I	Data Enable Timing Signal	
10	GND	P	Ground	
11	GND	P	Ground	
12	GND	P	Ground	
13	B5	I	Blue data signal (MSB)	
14	B4	I	Blue data signal	
15	B3	I	Blue data signal	
16	GND	P	Ground	
17	B2	I	Blue data signal	
18	B1	I	Blue data signal	
19	B0	I	Blue data signal (LSB)	
20	GND	P	Ground	
21	G5	I	Green data signal (MSB)	
22	G4	I	Green data signal	
23	G3	I	Green data signal	
24	GND	P	Ground	
25	G2	I	Green data signal	
26	G1	I	Green data signal	
27	G0	I	Green data signal (LSB)	
28	GND	P	Ground	
29	R5	I	Red data signal (MSB)	
30	R4	I	Red data signal	
31	R3	I	Red data signal	
32	GND	P	Ground	
33	R2	I	Red data signal	
34	R1	I	Red data signal	
35	R0	I	Red data signal (LSB)	
36	GND	P	Ground	
37	GND	P	Ground	
38	DCLK	I	Data Clock	
39	GND	P	Ground	
40	GND	P	Ground	

I: Input, P: Power

Notes:

- 1) NC Pin must be retained; this pin can't contact GND or other signal.
- 2) GND Pin must ground contact, can't be floating.







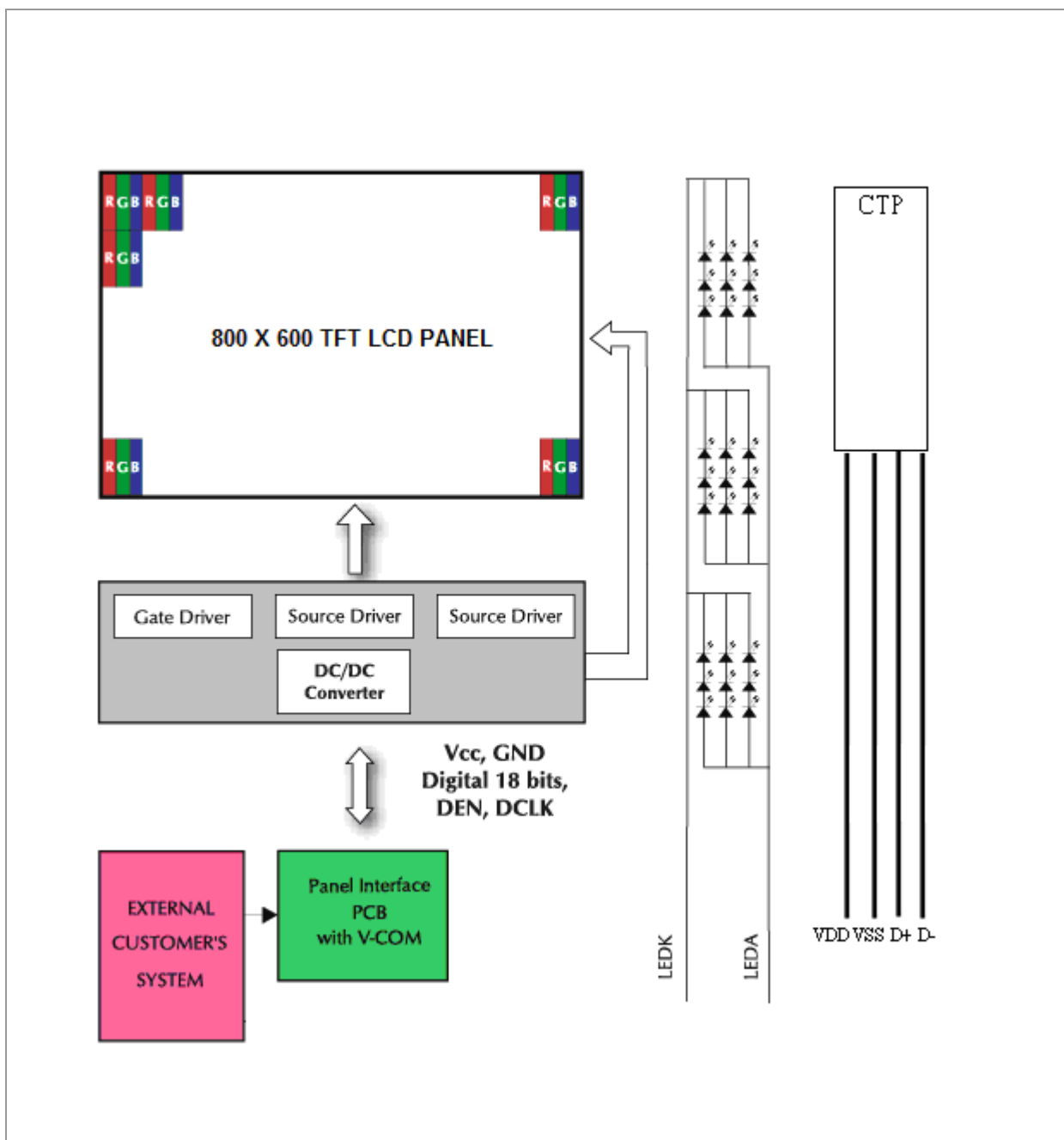

















5.2 Back Light Unit (Connector Part No: COMPATIBLE OF THE JST:BHSR-02VS-01(N).)

Pin No.	Symbol	Function	Remark
1	LEDA	Power Supply for LED backlight	RED
2	LEDK	GND for LED backlight	BLACK

5.3 Block Diagram



6. Displayed Color and Input Data

		Color & Gray Scale	Data Signal																	
			R5	R4	R3	R2	R1	R0	G5	G4	G3	G2	G1	G0	B5	B4	B3	B2	B1	B0
Basic Color		Black	0	0	0	0	0	0	0	0	0	0	0	0	0	0	0	0	0	0
		Red(0)	1	1	1	1	1	1	0	0	0	0	0	0	0	0	0	0	0	0
		Green(0)	0	0	0	0	0	0	1	1	1	1	1	1	0	0	0	0	0	0
		Blue(0)	0	0	0	0	0	0	0	0	0	0	0	0	1	1	1	1	1	1
		Cyan	0	0	0	0	0	0	1	1	1	1	1	1	1	1	1	1	1	1
		Magenta	1	1	1	1	1	1	0	0	0	0	0	0	1	1	1	1	1	1
		Yellow	1	1	1	1	1	1	1	1	1	1	1	1	0	0	0	0	0	0
		White	1	1	1	1	1	1	1	1	1	1	1	1	1	1	1	1	1	1
Red		Black	0	0	0	0	0	0	0	0	0	0	0	0	0	0	0	0	0	0
		Red(62)	0	0	0	0	0	1	0	0	0	0	0	0	0	0	0	0	0	0
		Red(61)	0	0	0	0	1	0	0	0	0	0	0	0	0	0	0	0	0	0
		Red(31)	0	1	1	1	1	1	0	0	0	0	0	0	0	0	0	0	0	0
		Red(1)	1	1	1	1	1	0	0	0	0	0	0	0	0	0	0	0	0	0
		Red(0)	1	1	1	1	1	1	0	0	0	0	0	0	0	0	0	0	0	0
		Green(62)	0	0	0	0	0	0	0	0	0	0	0	1	0	0	0	0	0	0
		Green(61)	0	0	0	0	0	0	0	0	0	0	1	0	0	0	0	0	0	0
Green		Green(31)	0	0	0	0	0	0	0	1	1	1	1	0	0	0	0	0	0	0
		Green(1)	0	0	0	0	0	0	1	1	1	1	1	0	0	0	0	0	0	0
		Green(0)	0	0	0	0	0	0	1	1	1	1	1	1	0	0	0	0	0	0
		Blue(62)	0	0	0	0	0	0	0	0	0	0	0	0	0	0	0	0	0	1
		Blue(61)	0	0	0	0	0	0	0	0	0	0	0	0	0	0	0	0	0	1
		Blue(31)	0	0	0	0	0	0	0	0	0	0	0	0	0	1	1	1	1	1
		Blue(1)	0	0	0	0	0	0	0	0	0	0	0	0	1	1	1	1	1	0
		Blue(0)	0	0	0	0	0	0	0	0	0	0	0	0	1	1	1	1	1	1

0: Low level voltage, 1: High level voltage

Each basic color can be displayed in 64 gray scales from 6 bit data signals. With the combination of total 18 bit data signals, the 262,144-color display can be achieved on the screen.

7. Projected Capacitive Touch Panel

7.1 Main Feature

Item	Specification	Unit
Screen Size	8.0 Inches	Diagonal
Type	Transparent Type Projected Capacitive Touch Panel	--
Input Mode	Human's Finger	--
Active Area	163.00 x 122.50	mm
Module Outline	204.60 x 164.60	mm
Interface	USB	--
Cover Glass Pencil-Handness	$\geq 6H(\text{min}) / 1.6\text{mm}$ Cover Glass	--
Report Rate	TBD	Points/sec
Response Time	TBD	ms
Digital Power Supply	5V DC (typ)	V
Power Consumption	(60)	mA
IC Solution	EETI(EXC7200 & EXC5404)	--

7.2 Pin Assignments and Definitions

Item	Name	I/O	Unit
1	VDD	p	Power Supply Voltage
2	GND	p	Ground
3	D+	I/O	USB Data D+
4	D-	I/O	USB Data D-
5	NC	-	NO Connect
6	NC	-	NO Connect
7	NC	-	NO Connect
8	NC	-	NO Connect

8. Reliability Condition

No change on display and in operation under the following test condition.

Condition: Unless otherwise specified, tests will be conducted under the following condition.

Temperature: 20±5°C.

Humidity: 65±5%RH.

Tests will be not conducted under functioning state.

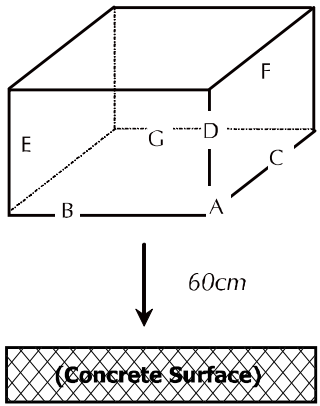
No.	Parameter	Condition	Notes
1	High Temperature Operating	70°C±2°C, 240hrs (Operation state).	
2	Low Temperature Operating	-20°C±2°C, 240hrs (Operation state).	1
3	High Temperature Storage	80°C±2°C, 240hrs.	2
4	Low Temperature Storage	-30°C±2°C, 240hrs.	1,2
5	High Temperature and High Humidity Operation Test	60°C±2°C, 90%, 240hrs.	1,2
6	Vibration Test	Total fixed amplitude: 1.5mm. Vibration Frequency: 10~55Hz. One cycle 60 seconds to 3 direction of X, Y, Z each 15 minutes.	3
7.	Drop Test	To be measured after dropping from 60cm high on the concrete surface in packing state.  <i>Dropping method corner dropping:</i> <i>A corner: Once edge dropping.</i> <i>B, C, D edge: Once face dropping.</i> <i>E, F, G face: Once.</i>	

- Notes:
1. No dew condensation to be observed.
 2. The function test shall be conducted after 4 hours storage at the normal temperature and humidity after removed from the test chamber.
 3. Vibration test will be conducted to the product itself without putting I in a container.

9. Dimensional Outlines

